Front-Panel Operation Reference

HP 16530A/16531A
Digitizing Oscilloscope Module
for the HP 16500A Logic Analysis System



© Copyright Hewlett Packard Company 1987

Manual Set Part Number 16530-90902
Microfiche Part Number 16530-90802

Printed in U.S.A. October 1987

Product Warranty

This Hewlett-Packard product has a warranty against defects in material and workmanship for a period of one year from date of shipment. During warranty period, Hewlett-Packard Company will, at its option, either repair or replace products that prove to be defective.

For warranty service or repair, this product must be returned to a service facility designated by Hewlett-Packard. However, warranty service for products installed by Hewlett-Packard and certain other products designated by Hewlett-Packard will be performed at the Buyer's facility at no charge within the Hewlett-Packard service travel area. Outside Hewlett-Packard service travel areas, warranty service will be performed at the Buyer's facility only upon Hewlett-Packard's prior agreement and the Buyer shall pay Hewlett-Packard's round trip travel expenses.

For products returned to Hewlett-Packard for warranty service, the Buyer shall prepay shipping charges to Hewlett-Packard and Hewlett-Packard shall pay shipping charges to return the product to the Buyer. However, the Buyer shall pay all shipping charges, duties, and taxes for products returned to Hewlett-Packard from another country.

Hewlett-Packard warrants that its software and firmware designated by Hewlett-Packard for use with an instrument will execute its programming instructions when properly installed on that instrument. Hewlett-Packard does not warrant that the operation of the instrument, software, or firmware will be uninterrupted or error free.

Limitation of Warranty

The foregoing warranty shall not apply to defects resulting from improper or inadequate maintenance by the Buyer, Buyer-supplied software, or interfacing, unauthorized modification or misuse, operation outside of the environmental specifications for the product, or improper site preparation or maintenance.

NO OTHER WARRANTY IS EXPRESSED OR IMPLIED.
HEWLETT-PACKARD SPECIFICALLY DISCLAIMS THE IMPLIED WARRANTIES OF MERCHANTABILITY AND FITNESS FOR A PARTICULAR PURPOSE.

Exclusive Remedies THE REMEDIES PROVIDED HEREIN ARE THE BUYER'S SOLE AND EXCLUSIVE REMEDIES. HEWLETT-PACKARD SHALL NOT BE LIABLE FOR ANY DIRECT, INDIRECT, SPECIAL INCIDENTAL, OR CONSEQUENTIAL DAMAGES, WHETHER BASED ON CONTRACT, TORT, OR ANY OTHER LEGAL THEORY.

Assistance Product maintenance agreements and other customer assistance agreements are available for Hewlett-Packard products.

For any assistance, contact your nearest Hewlett-Packard Sales and Service Office. Addresses are provided at the back of this manual.

Certification Hewlett-Packard Company certifies that this product met its published specifications at the time of shipment from the factory. Hewlett-Packard further certifies that its calibration measurements are traceable to the United States National Bureau of Standards, to the extent allowed by the Bureau's calibration facility, and to the calibration facilities of other International Standards Organization members.

Safety This product has been designed and tested according to International Safety Requirements. To ensure safe operation and to keep the product safe, the information, cautions, and warnings in this manual must be heeded.

Table of Contents

Introduction

Chapter 1:

What is the HP 16530A/16531A?

- 1-1 Introduction
 - 1-1 Key Features
 - 1-2 Accessories Supplied
 - 1-2 Probe Accessories Available
 - 1-3 Menu Field Index
 - 1-4 Menu Maps
 - 1-4 Channel Menu Map
 - 1-5 Trigger Menu Map
 - 1-6 Display Menu Map
 - 1-6 Auto-Measure Menu Map
 - 1-7 Calibration Menu Map
 - 1-8 Common Function Menu Map
 - 1-9 Marker Field Menu Map
-

Chapter 2:

Basic User Interface Information

- 2-1 User Interface Devices
- 2-1 System Power Up
- 2-2 Using the Touch Screen
- 2-3 Module Menus
- 2-4 Moving to the Digitizing Scope
- 2-5 Digitizing Scope Menus
- 2-6 Data Entry Fields
- 2-6 What's the Knob For?
- 2-7 Using the Mouse

Chapter 3:

Cables and Probes

- 3-1 Inputs and Outputs
- 3-2 Connecting BNC Cables
- 3-3 Connecting Probes

Chapter 4:

Channel Menu

- 4-1 Introduction
- 4-2 Channel Menu Tree
- 4-3 Input Field
- 4-4 V/Div Field
- 4-5 Offset Field
- 4-6 Probe Field
- 4-7 Impedance Field
- 4-8 Preset Field

Chapter 5:

Timebase Functions

- 5-1 Introduction
- 5-1 Instrument Setup
- 5-2 s/Div Field
- 5-3 Zoom
- 5-5 Delay Field
- 5-6 Pan
- 5-8 Sample Period Display

Chapter 6:

Trigger Menu

- 6-1 Introduction
- 6-2 Trigger Menu Tree
- 6-3 Mode Field
- 6-4 Trigger Marker
- 6-5 Immediate Trigger Mode
- 6-6 Edge Trigger Mode
 - 6-6 Source Field
 - 6-7 Level Field
 - 6-8 Slope Field
- 6-9 Auto-Trig Field
- 6-10 Count Field
- 6-11 Pattern Trigger Mode
 - 6-12 Channel-Pattern Field
 - 6-14 When Field
 - 6-15 Auto-Trig Field
 - 6-16 Count Field
- 6-17 Pattern Trigger Exercise
 - 6-17 Connecting the Equipment
 - 6-17 Setting Up the Oscilloscope
 - 6-19 Entering a Trigger Pattern

Chapter 7:

Autoscale

- 7-1 Autoscale Field
- 7-3 When a Signal is Found
- 7-4 If No Signal is Found

Chapter 8:

Running the Oscilloscope

- 8-1 Introduction
- 8-1 Run/Stop Field
- 8-2 Single Mode
- 8-3 Repetitive Mode
- 8-3 Reminder

Chapter 9:

Marker Measurements

- 9-1 Introduction
- 9-2 Markers Menu Tree
- 9-3 Marker Measurements
 - 9-3 Connecting the Equipment
 - 9-3 Setting Up the Oscilloscope
- 9-4 Manual Marker Measurements
 - 9-5 Trig to X Field
 - 9-5 Trig to O Field
 - 9-6 X to O Field
 - 9-6 Channel Label Field
- 9-8 Automatic Marker Measurements
 - 9-9 Set on Field
 - 9-10 at Level Field
 - 9-10 Slope Field
 - 9-10 Occur Field
 - 9-11 Statistics Field
 - 9-12 Run Until Time X-O Field
- 9-15 Auto-Marker Exercise

Chapter 10:

Display Menu

- 10-1 Introduction
- 10-1 Display Menu Tree
- 10-2 Mode Field
 - 10-3 Normal Mode
 - 10-4 Average Mode
 - 10-5 Accumulate Mode
- 10-6 Connect Dots Field

Chapter 11:

Auto-Measure Menu

- 11-1 Introduction
- 11-1 Auto-Measure Menu Map
- 11-2 Top and Base Voltages
- 11-3 Automatic Measurement Setup
 - 11-3 Connecting the Equipment
 - 11-3 Setting Up the Oscilloscope
- 11-4 Auto-Measure Menu
- 11-5 Input Field
- 11-5 Measurement Field
- 11-6 Rise Time Measurement
- 11-7 Fall Time Measurement
- 11-9 Vp_p Measurement
- 11-10 Period and Frequency Measurements
- 11-11 +Width and -Width Measurements
- 11-12 Preshoot and Overshoot Measurements

Chapter 12:

Waveform Selection

- 12-1 Introduction
- 12-2 Waveform Selection Menu Map
- 12-3 Waveform Selection Setup
 - 12-3 Connecting the Equipment
 - 12-3 Setting Up the Oscilloscope
- 12-5 Replacing a Channel
- 12-7 Inserting a Channel
- 12-9 Deleting a Channel
- 12-10 Waveform Math and Overlay
 - 12-10 Single
 - 12-11 Overlay
- 12-13 Waveform Math (Chan+Chan, Chan-Chan)

Chapter 13: Saving and Recalling Setups

- 13-1 Introduction
- 13-1 Storing a Configuration
- 13-8 Loading a Configuration
- 13-8 Autoloading a Configuration

Chapter 14: Using a Printer

- 14-1 Setting Printer Configuration
- 14-1 Printing Options
- 14-2 Printing On-Screen Data

Chapter 15: Using a Dual-Timebase Oscilloscope

- 15-1 Introduction
- 15-2 Setting Up the Intermodule Menu
- 15-4 Status
- 15-4 Time Correlation Bars
- 15-5 Skew
- 15-6 Setting Up the Oscilloscopes
- 15-6 Connect a Signal
- 15-6 Acquire a Waveform with Oscilloscope E
- 15-7 Set the Trigger Mode
- 15-8 Add Input Labels
- 15-9 Acquire Waveforms
- 15-11 Time Correlation Bars

Chapter 16

Calibration Menu

- 16-1 Introduction
- 16-1 Calibration Interval
- 16-2 Calibration Menu Map
- 16-2 Instrument Warmup
- 16-3 Calibration Menu
- 16-4 Maintaining Calibration Integrity
- 16-4 Calibration Prerequisites
- 16-5 Vertical Calibration
- 16-6 Trigger Level Calibration
- 16-7 Delay Calibration
- 16-8 Channel-to-Channel Skew

Appendix A:

Installing New Oscilloscope Boards into the Mainframe

- A-1 Introduction
- A-1 Initial Inspection
- A-1 Power Requirements
- A-1 Dual Timebase Installation
- A-2 Installation
- A-2 Module Installation
- A-2 Installation Considerations
- A-3 Procedure
- A-7 Adding Acquisition Cards
- A-10 Operating Environment
- A-11 Storage
- A-12 Packaging
- A-12 Tagging for Service

Appendix B:

Specifications and Characteristics

- B-1 Specifications
- B-3 Characteristics
- B-6 General Characteristics

Appendix C:

Automatic Measurement Algorithms

- C-1 Introduction
- C-1 Measurement Setup
- C-1 Making Measurements
- C-2 Top and Base Voltages
- C-3 Measurement Algorithms
 - C-3 Frequency (Freq)
 - C-3 Period
 - C-3 Peak-to-Peak Voltage (Vp_p)
- C-4 Positive Pulse Width (+Width)
- C-4 Negative Pulse Width (-Width)
- C-4 Risetime
- C-4 Falltime
- C-5 Preshoot and Overshoot

Index

Introduction

About this manual...

Welcome to the new generation of HP logic analyzers! The HP 16500A Logic Analysis System has been designed to be easier to use than any Hewlett-Packard logic analyzer before. In addition, because of its configurable architecture, it can easily be tailored to your specific logic design and debug needs.

The user interface of the HP 16500A was designed for the most intuitive operation as possible. Pop-up windows and color graphics help lead you through setups and measurements so you won't have to memorize a lot of steps. As you read this manual and the other manuals about the mainframe and acquisition modules, you will see just how easy the HP 16500A is to use.

This digitizing oscilloscope reference manual is divided as follows:

- Chapters 1 and 2 contain introductory information about the digitizing oscilloscope features and the user interface.
- Chapters 3 through 7 give you information on how to hook up the probes and how to set up the vertical, horizontal, and trigger in preparation for making measurements.
- Chapters 8 through 12 provide information on viewing waveforms and making measurements on the waveforms.
- Chapters 13 through Appendix C discuss other oscilloscope functions such as storing and recalling setups, printing, calibration, specifications, etc.

If you aren't familiar with the HP 16530A/16531A Digitizing Oscilloscope, we suggest you read the *HP 16530A/16531A Getting Started Guide*. This guide contains tutorial examples on the basic functions of the digitizing oscilloscope.

If you're new to digitizing oscilloscopes...or just need a refresher, we think you'll find *Feeling Comfortable with Digitizing Oscilloscopes* valuable reading. It will eliminate any misconceptions or confusion you may have about their application, and will show you how to get the most out of your new scope.

1

What is the HP 16530A/16531A?

Introduction

The HP 16530A/16531A module is a 400-megasample/second, 100-MHz single-shot and repetitive bandwidth digitizing oscilloscope can be installed in the HP 16500A Logic Analysis System mainframe. The HP 16530A is a 400-megasample/second timebase card and the HP 16531A is a 2-channel acquisition card.

Key Features

- 400 megasample/second digitizing rate
- 100-MHz single-shot (real-time) bandwidth
- 4k samples per measurement per channel
- 2-channel simultaneous acquisition, expandable to 4, 6, or 8

User Convenience

- Automatic waveform scaling
- Hardcopy to graphics printers
- ECL and TTL presets

Measurement

- Automatic pulse parameter measurements
- Channel-to-channel time interval measurements
- Markers for time and voltage readouts

Vertical Channel

- 2, 4, 6, or 8 fully configured vertical channels
- Continuously variable sensitivity range of 40 mV to 16 V
- 6-bit resolution
- Probe attenuation from 1:1 to 1000:1
- 50 Ω dc or 1 M Ω dc input coupling

Trigger

- Internal, external, or immediate modes
- Edge or pattern triggering
- Delayed trigger by events and/or time
- Trigger point marker displayed

Display

- Single, average, or cumulative acquisitions
- Connect-the-dots
- Chan+Chan, Chan-Chan, and waveform overlay
- Combine waveforms from other HP 16500A modules

Accessories Supplied

The following accessories are supplied with the HP 16530A/31A Digitizing Oscilloscope Module:

HP 16531A Acquisition card

- 2 HP 10018A 10:1, 1 M Ω , 10 pF mini-probes, 2 m
- 2 right angle BNC adapters (HP 1250-0076)

HP 16530A Timebase card

- 1 operating manual set (covers complete module)
 - 1 service manual (covers complete module)
-

Probe Accessories Available

The following probe accessories are not supplied with the HP 16530A/31A, but may be ordered separately:

HP 10503A	BNC-to-BNC cable, 1.2 m
HP 10017A	10:1, 1 M Ω , 8 pF mini-probe, 1 m
HP 10020A	10:1, 100:1, 10 M Ω , 10 pF resistive divider probe set, 1.5 m
HP 10021A	1:1, 36 pF mini-probe, 1 m
HP 10022A	1:1, 62 pF mini-probe, 1 m
HP 10026A	1:1, 50 Ω mini-probe, 1 m
HP 10027A	1:1 50 Ω mini-probe, 2 m
HP 10032A	100:1, 3 M Ω , 3 pF mini-probe, 1 m
HP 10240B	BNC-to-BNC ac coupling capacitor
HP 10211A	24-pin IC test clip

What is the HP 16530A/16531A?

1-2

Menu Field Index

The following diagram shows the fields on the digitizing oscilloscope menus. The table lists the chapters where the fields are described.

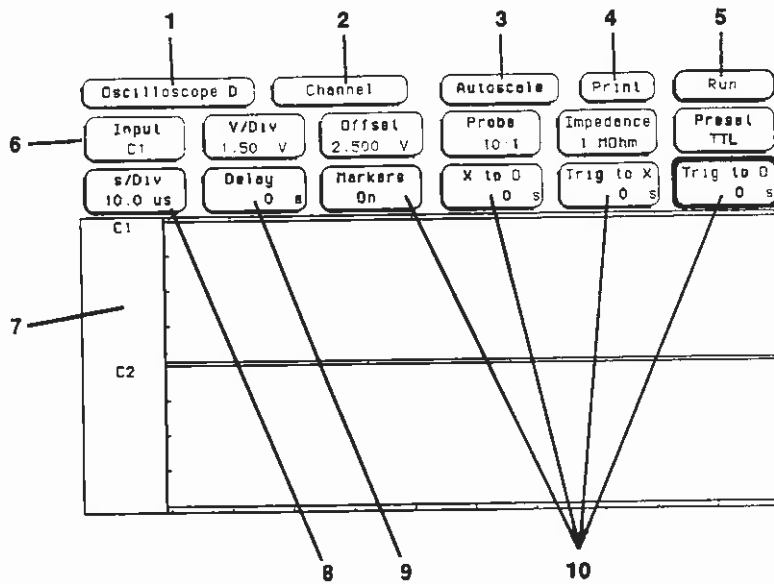

Item	Description	Chapter
1	Module field	2
2	Menu Field	2
	Channel menu	4
	Trigger menu	6
	Display menu	10
	Auto-Measure menu	11
	Calibration menu	16
3	Autoscale	7
4	Print	14
5	Run/Stop	8
6	Menu specific fields	See item 2
7	Waveform selection	12
8	s/Div	5
9	Delay	5
10	Markers	9

What is the HP 16530/16531A?

Menu Maps

The following pages show the menu maps for all functions of the oscilloscope. Functions which are common to several menus are shown on separate menu maps at the end of this chapter.

Channel Menu Map

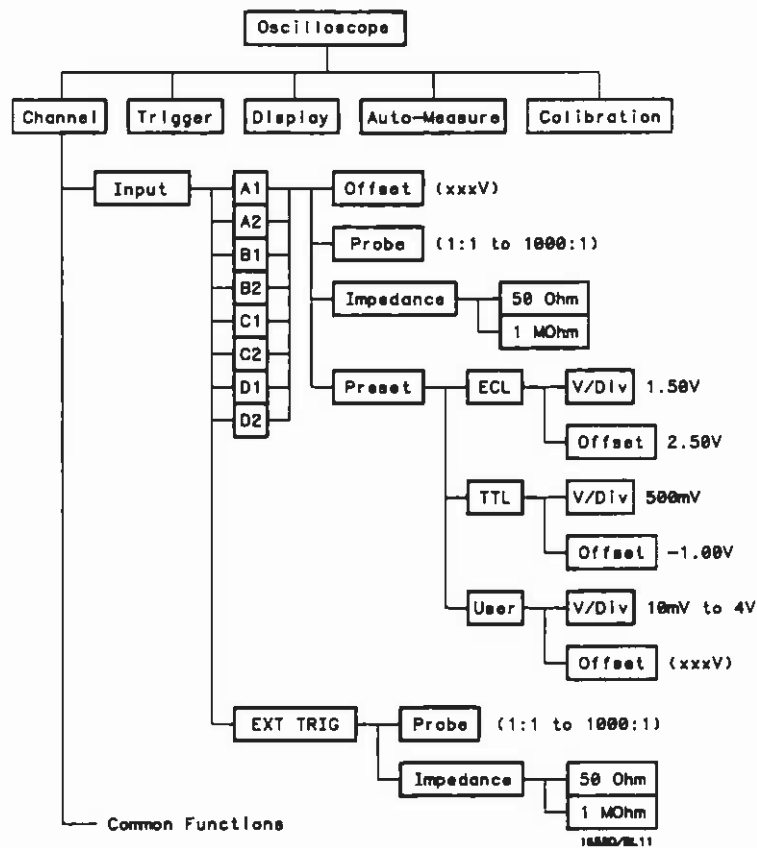

What is the HP 16530/16531A?

Trigger Menu Map

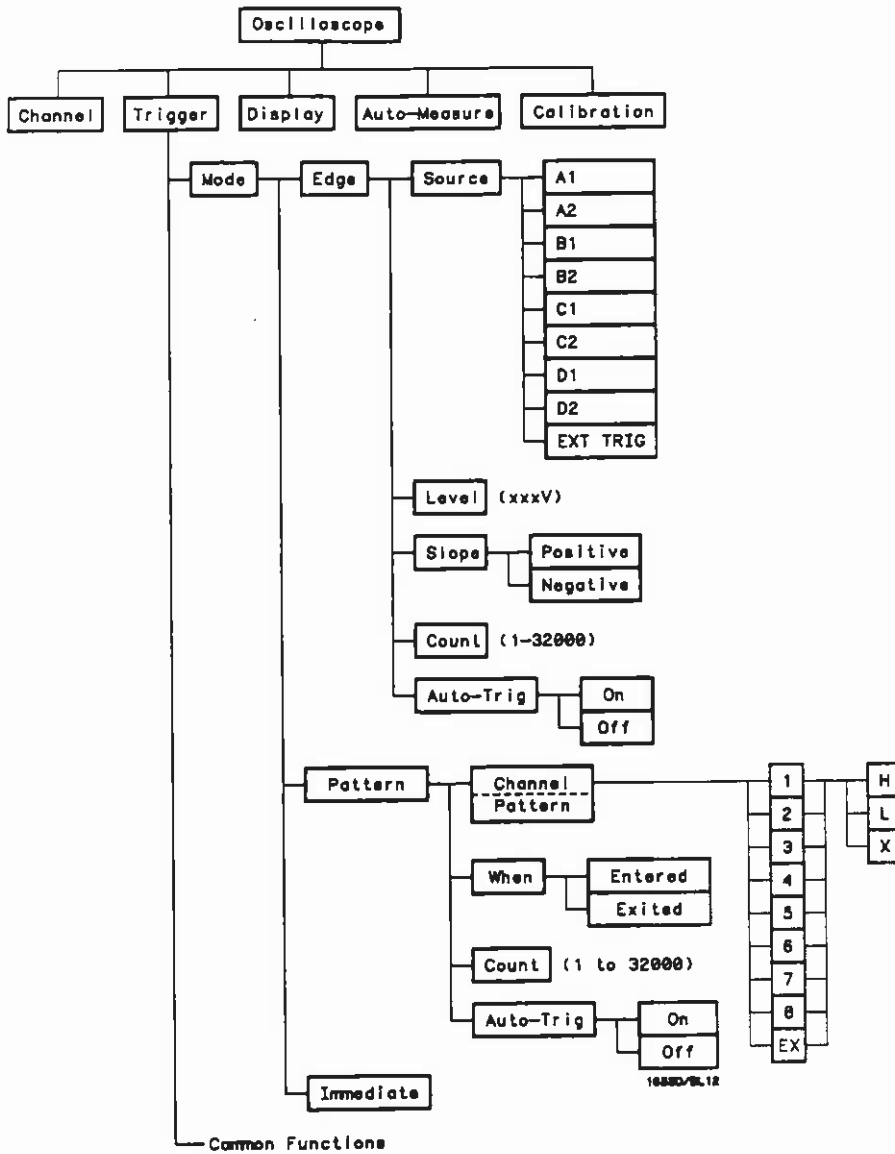

What is the HP 16530/16531A?

Display Menu Map

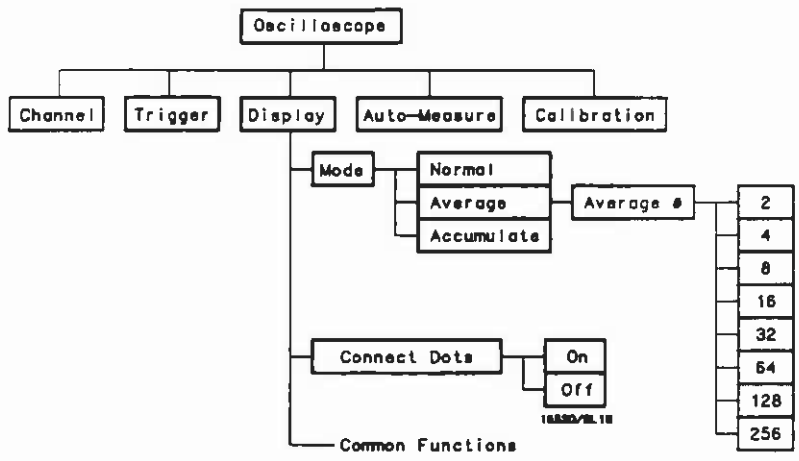

Auto-Measure Menu Map

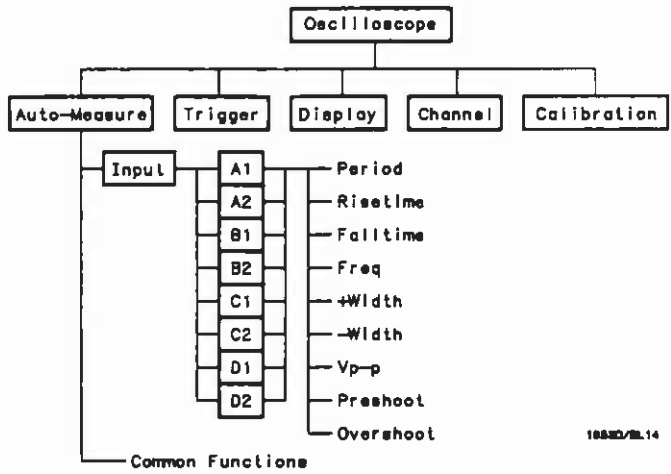

What is the HP 16530/16531A?
1-6

Calibration Menu Map

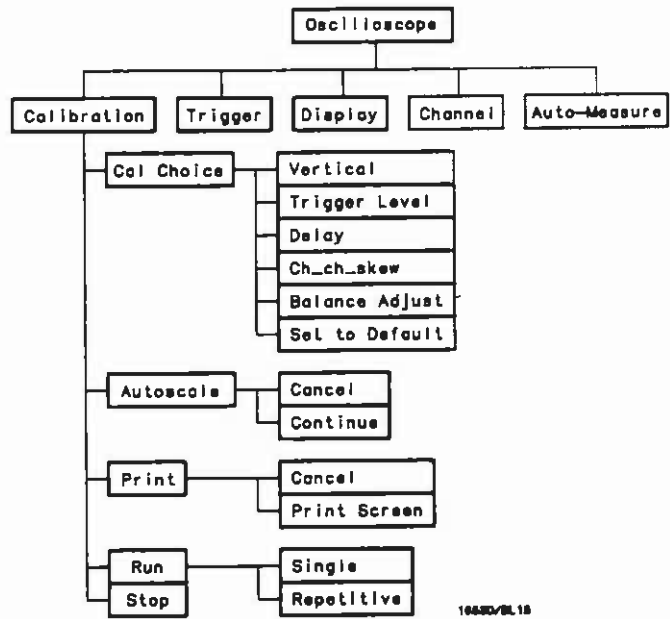

Common Functions Menu Map

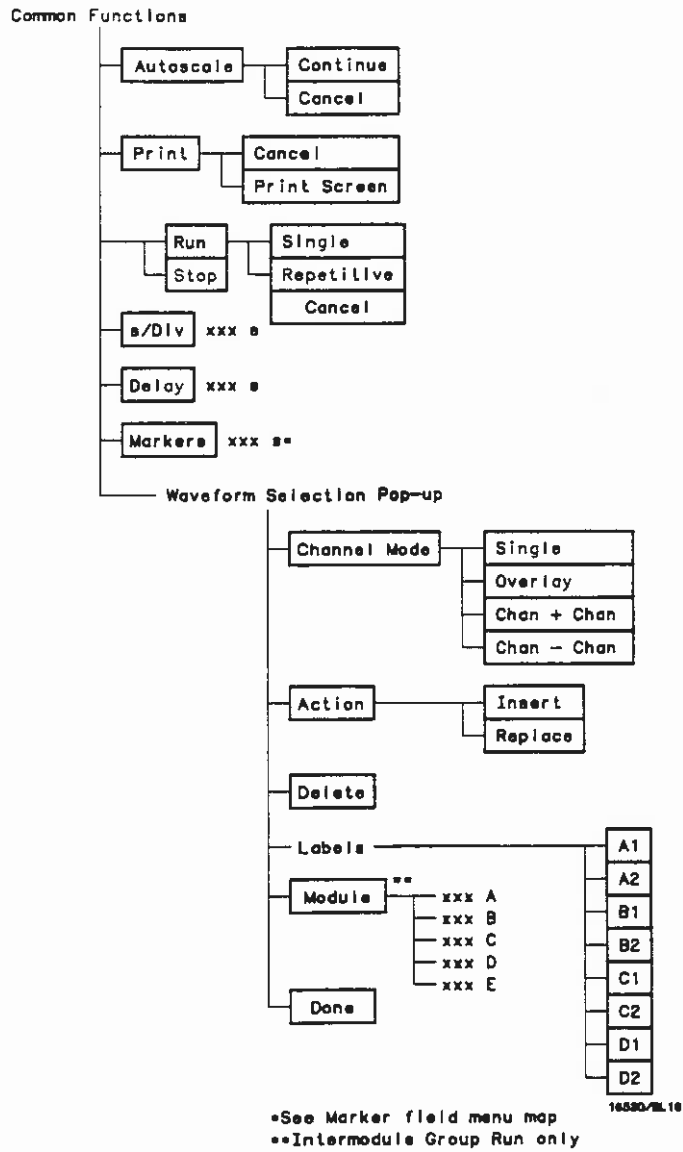

What is the HP 16530/16531A?
1-8

Markers Field Menu Map

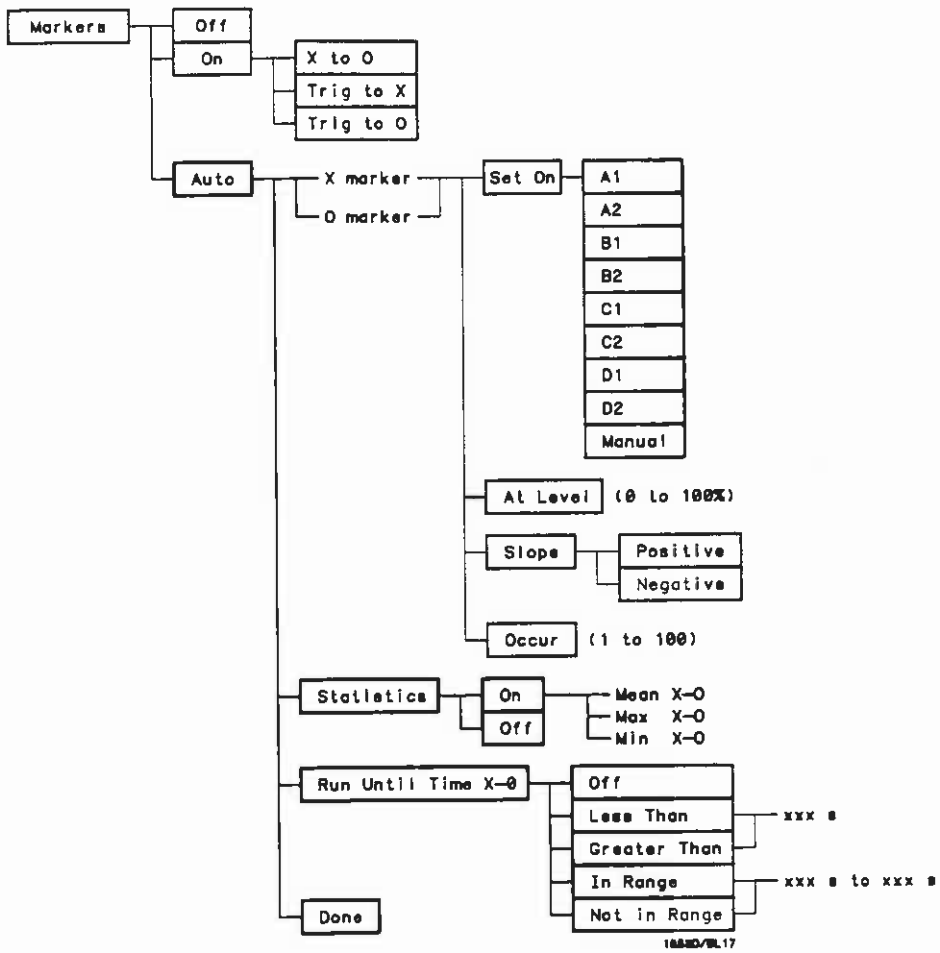

What is the HP 16530/16531A?

2

Basic User Interface Information

User Interface Devices

The HP 16500A has three user interface devices: the knob on the front panel, the touch-sensitive screen, and the optional mouse. If you are unfamiliar with any of these, this chapter covers the basic concepts of their use. For more detailed information, refer to the HP 16500A reference manual.

System Power Up

When the HP 16500A system is powered up, the menu you see should look similar to the one shown below.

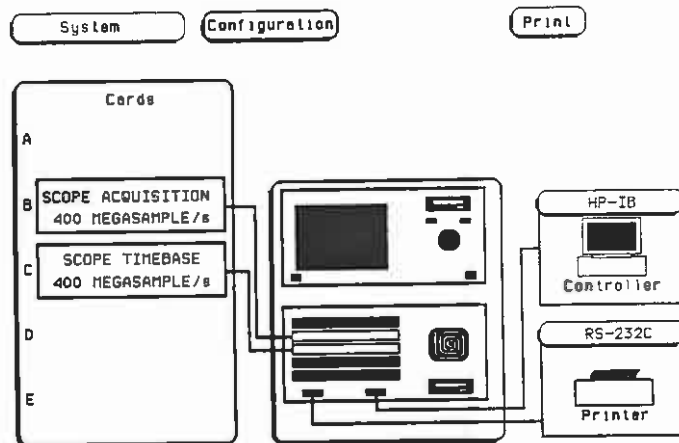

Using the Touch Screen

Any dark-blue field on screen is a "touchable" field. That is, if you touch a dark-blue field, the field will toggle to another value, or a pop-up will appear allowing you to select another function. For example, touch the dark-blue field labeled **System** in the upper left of the screen. A pop-up appears showing all the modules of the mainframe. The actual order and content of this pop-up may vary depending on the modules you have installed and which slots the modules are in.

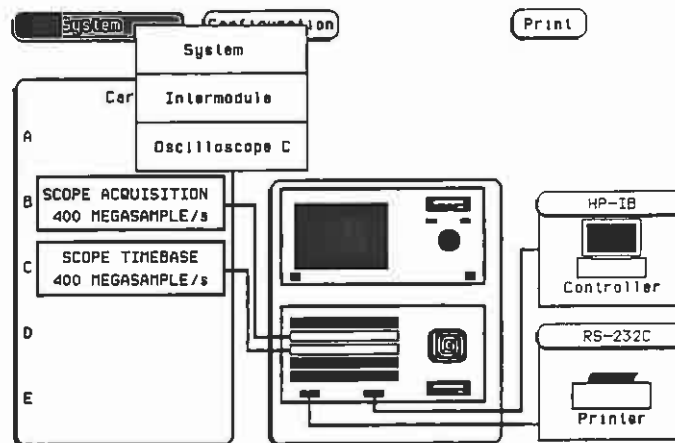

Notice that the **System** field in the pop-up is highlighted in light blue. This tells you that you are in a system menu. To move to any module in the list, touch that field in the pop-up. The pop-up will close and the module chosen will appear on screen.

If you are in any other module menu, you can return to **System** by touching the module field in the upper left of the screen. When the pop-up appears, notice again that the module you are in is highlighted in light blue. Remember that the dark-blue field in the upper left of the screen allows you to move among the modules.

Module Menus

Each module may have several menus within it. To see these menu selections, touch the dark-blue field second from the left at the top of the screen.

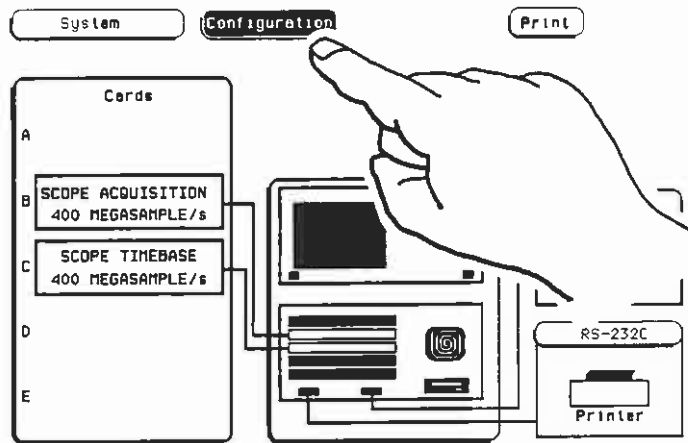

This menu field works the same as the module field to the left of it, except instead of showing all the modules, the menus within each module are displayed. For instance, if you touch this menu field while you are in **System**, you'll get a pop-up that looks like the one shown below.

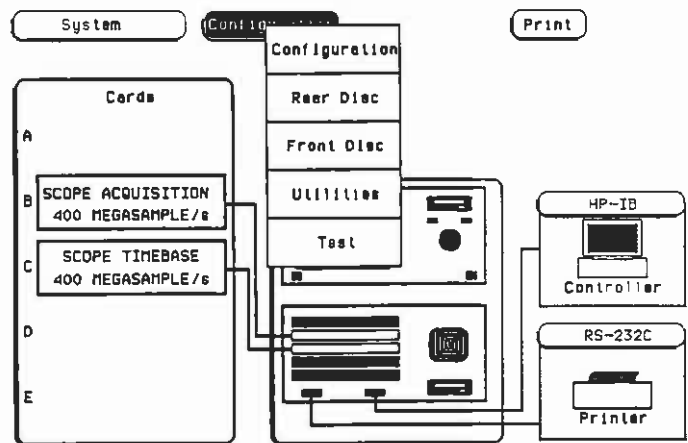

Moving to the Digitizing Scope

Touch the module field in the upper left of the screen. A pop-up will appear similar to that shown below displaying all the modules in the mainframe. The actual order and content of the pop-up will vary depending on the modules you have installed and their slots. The capitalized letter to the right of the module name refers to the slot in the mainframe where the module is installed.

In this example, to get to the digitizing scope menus, you would touch the **Oscilloscope C** field.

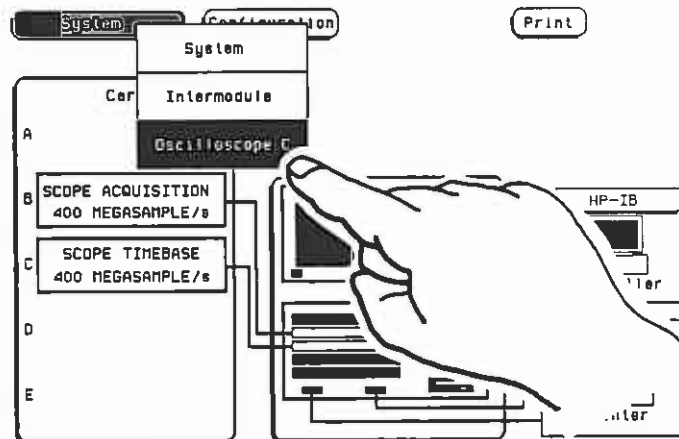

This will bring up the digitizing scope Channel menu.

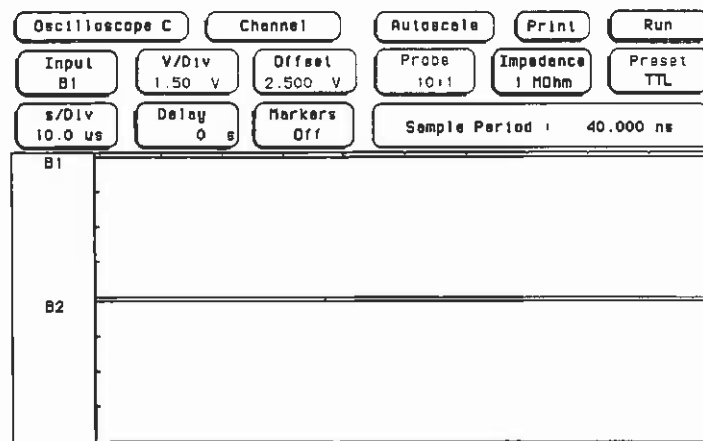

Digitizing Scope Menus

The digitizing scope has five menus. You can access them by touching the menu field to the right of the **Oscilloscope C** field. Touch the **Channel** menu field which is currently being displayed.

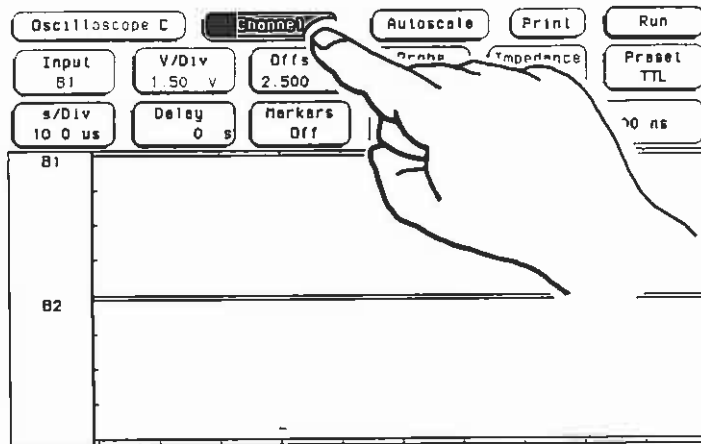

A pop-up appears with all the digitizing scope menu selections.

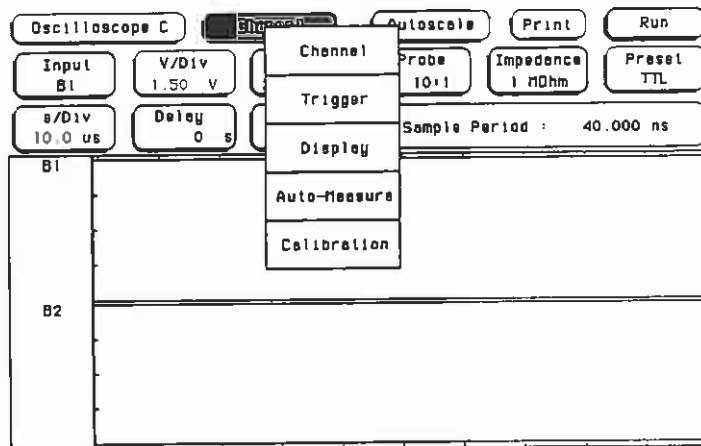

The following chapters will familiarize you with these scope menus. For now, touch the **Channel** field in the pop-up menu to return to the **Channel** menu. Just remember that the field next to **Oscilloscope** always shows which scope menu is displayed.

Data Entry Fields

When you need to enter alphanumeric or numeric data in some fields, a pop-up keypad will appear on screen to allow you to enter the information. In this pop-up, there is a field labeled **DONE**. This field lets the instrument know that you are finished entering data. The keypad pop-up will not close until you touch the **DONE** field.

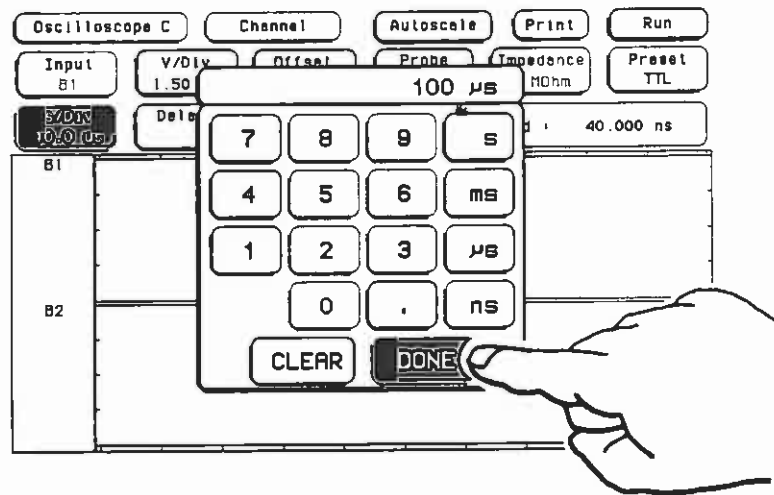

What's the Knob For?

To the right of the screen is a knob. Turning the knob allows you to increment or decrement values in a selected numeric field in the digitizing scope menus.

Using the Mouse

Everything that can be done with the touch screen and knob on the HP 16500A can also be done with the optional mouse. The mouse plugs into the connector in the lower right of the front panel. As soon as the mouse is plugged in, it is active.

When the mouse is plugged in, a white cursor (cross) appears on screen. Moving the mouse causes the cursor to move. To "touch" a field with the mouse, move the cursor to the field and press the left mouse button.

To use the mouse to perform the functions of the front-panel knob, hold down the right mouse button and move the mouse. When you release the right button on the mouse, the function returns to the cursor.

3

Cables and Probes

Inputs and Output

Each HP 16531A Acquisition Card has two vertical signal inputs. The inputs are on the module at the rear of the mainframe. INPUT 1 is to the left.

The two connectors on the HP 16530A Timebase Card on the rear of the mainframe are the external trigger (EXT TRIG) Input and the COMPENSATION SIGNAL output. The COMPENSATION SIGNAL 50Ω output is -1.2 kHz square wave with high amplitude near -200 mV and low amplitude near -400 mV when connected to a 50Ω load. This square wave is used for probe compensation adjustment (see your probe operating note) and is also used in examples throughout this manual.

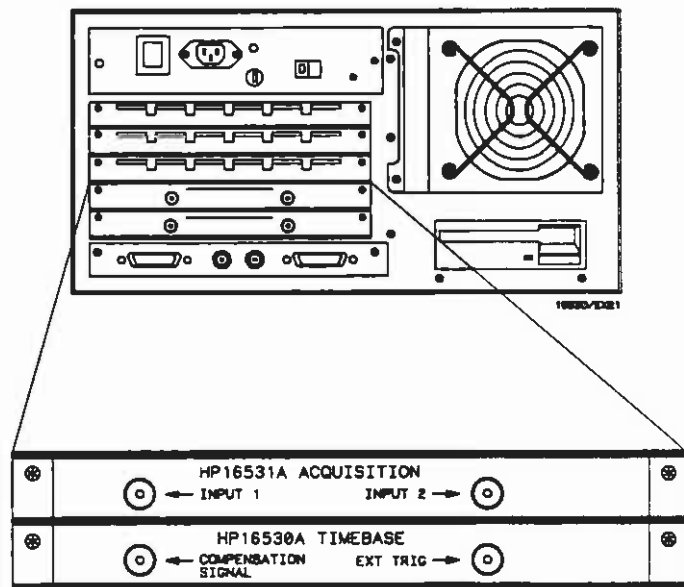

Connecting BNC Cables

BNC cables can be connected directly to the BNC connectors on the acquisition card or timebase card. The HP 10503A 1.2 metre BNC-to-BNC cable is not provided with the instrument, but can be ordered separately.

Connecting Probes

Probes may also be connected directly to the BNC input connectors on the acquisition card or external trigger input on the timebase card.

Two right-angle BNC adapters (HP 1250-0076) are supplied with each acquisition card. Connecting the right-angle adapters to the inputs, and then connecting the probes to the right-angle adapters keep the probes from protruding beyond the plastic standoffs on the rear of the instrument.

4

Channel Menu

Introduction

The **Channel** menu controls the vertical sensitivity, offset, probe attenuation factor, and input impedance of all input channels, as well as the probe attenuation factor and Input Impedance of the external trigger input. The **Channel** menu also allows you to preset vertical sensitivity, offset, and trigger level for ECL and TTL logic levels. The default **Channel** menu is shown below.

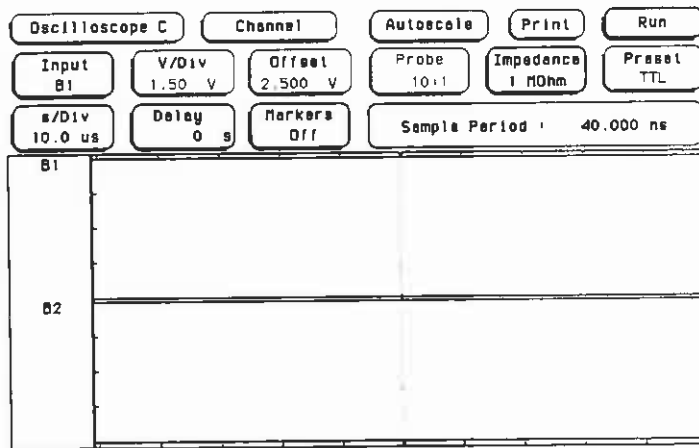

Channel Menu Map

The menu map for the Channel menu is shown below.

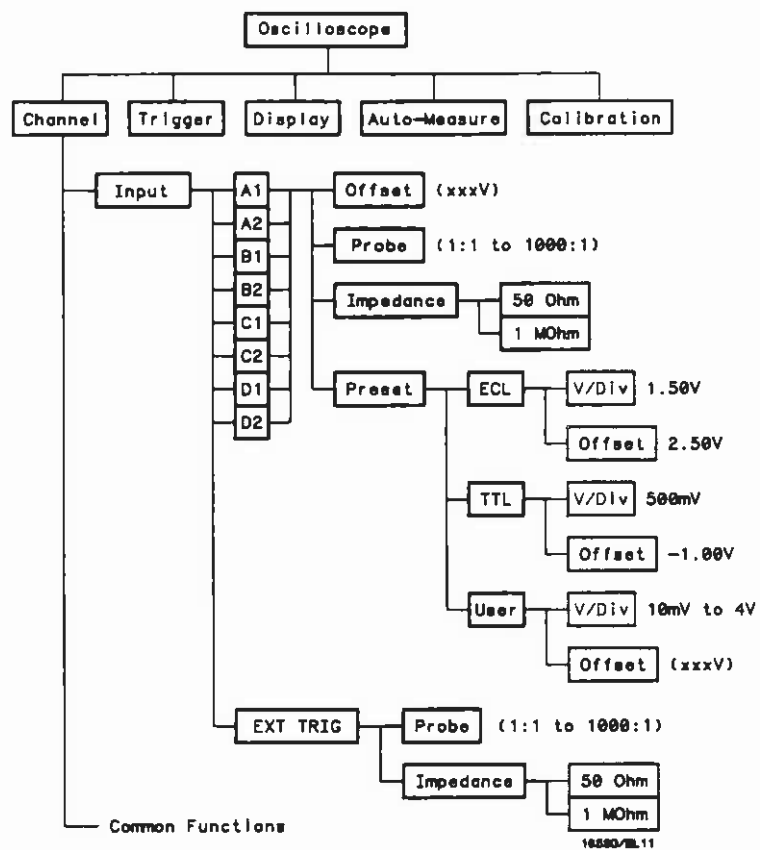

Input Field

The **Input** field selects the input source for the channel parameters displayed on the **Channel** menu.

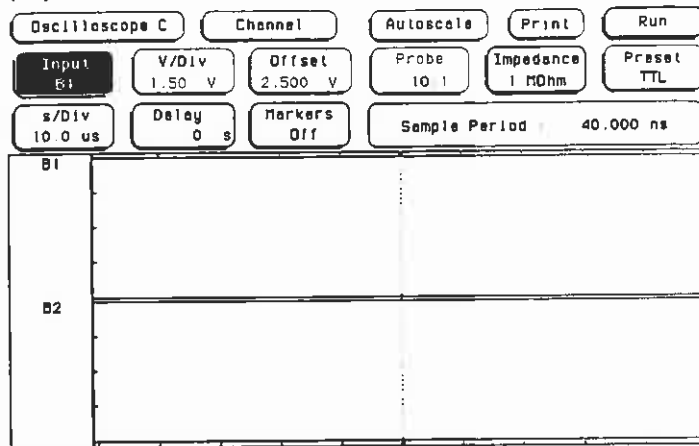

When you touch the **Input** field, a pop-up appears showing all available input channels and external trigger. Two inputs are available for each mainframe module slot A, B, C, and D; the actual pop-up contents is dependent upon which slots the HP 16530A Acquisition boards are installed. The HP 16531A Timebase board is identified by the slot shown in the **Oscilloscope** module field.

The default **Input** field selection is the lowest letter/number combination. For example, if an acquisition card is installed in mainframe slot A, the **Input** field will display **A1**.

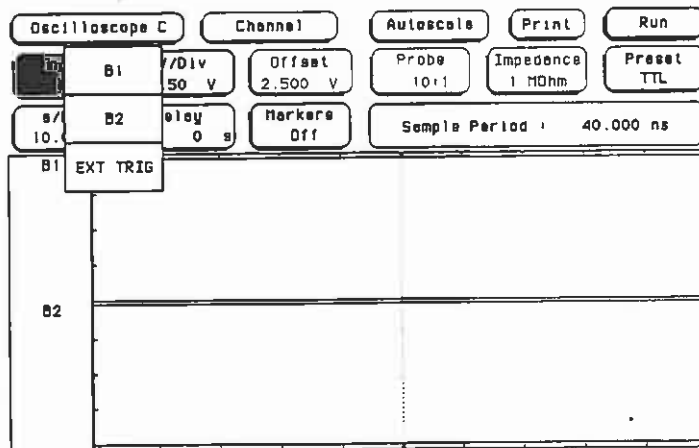

V/Div Field

The **V/Div** field sets the vertical sensitivity of the channel selected in the **Input** field. Vertical sensitivity determines the size of a waveform displayed on screen and is measured in volts/division. Each waveform display is divided into four vertical divisions. The divisions are marked by small tan tick marks at the left and right sides of the waveform display.

When the **V/Div** field is selected, the vertical sensitivity can be changed by turning the knob. As the vertical sensitivity is changed, the signal expands and compresses in both directions vertically from the center of the display. As you turn the knob, the vertical sensitivity changes in a 1-2-4 sequence from 10 mV/div to 4 V/div.

Vertical sensitivity can also be entered from the pop-up keypad. The keypad will appear when you touch the **V/Div** field when the field is light blue. Any value from 10 mV/div to 4 V/div can be entered from the keypad. The vertical sensitivity value can be set to the two most significant digits. For example, if you entered a value of 154 mV, the value would be truncated to 150 mV.

The default value for the **V/Div** field is 1.5 V (TTL preset value).

Note

*If acquisitions have been stopped (see chapter 8), vertical sensitivity changes will not be reflected on the waveform until **Run** is touched and the next acquisition is displayed.*

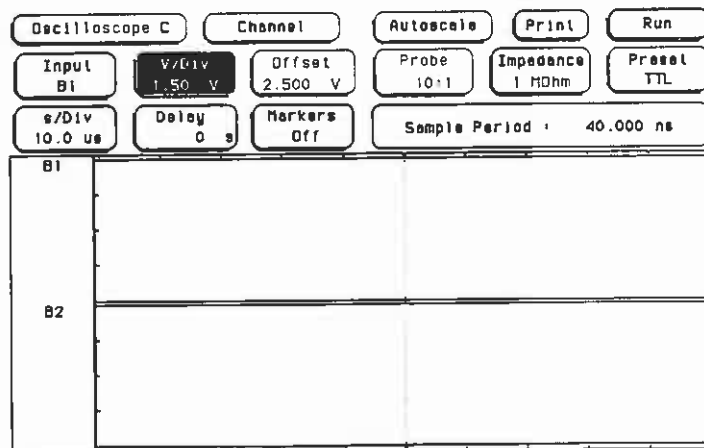

Offset Field

Offset is the voltage represented at the center vertical tick mark in the waveform display. Offset is a dc voltage that is added or subtracted from the input signal so that the waveform can be shown centered on the waveform display.

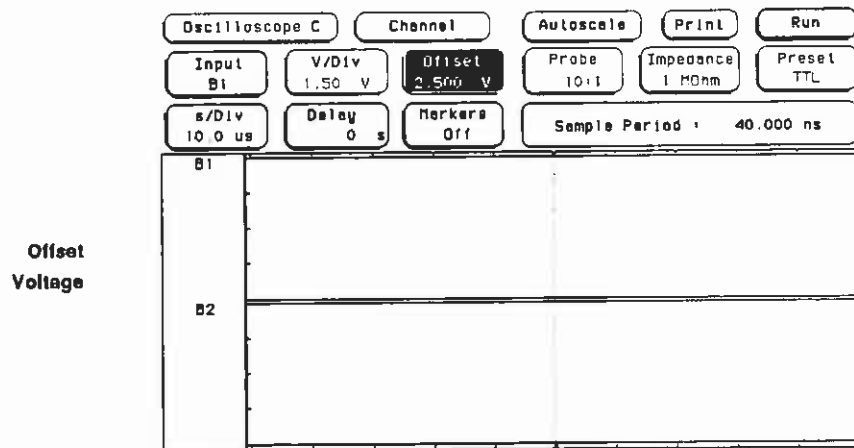

Offset range and resolution is dependent on vertical sensitivity:

V/Div	Offset	
	Range	Resolution
<200 mV	±800 mV	1 mV
≥200 mV	±16 V	10 mV

When the **Offset** field is selected, the offset value of the channel selected in the **Input** field can be changed by turning the knob. As offset is changed, the position of the waveform moves up or down on the waveform display. Offset works similar to the vertical position control of an analog oscilloscope, but offset is calibrated.

Offset can also be entered from the pop-up keypad. The keypad will appear when you touch the **Offset** field when the field is light blue. Any valid offset value can be entered from the keypad.

The default value for the **Offset** field is 2.5 V (TTL preset value).

Note

*If acquisitions have been stopped (see chapter 8), offset changes will not be reflected on the waveform until **Run** is touched and the next acquisition is displayed.*

Probe Field

The **Probe** field sets the probe attenuation factor for the channel or external trigger selected in the **Input** field. The probe attenuation factor can be set from 1:1 to 1000:1 in increments of 1. When the **Probe** field is selected, the probe attenuation factor can be changed by turning the knob or by entering a value from the pop-up keypad.

When you select a probe attenuation factor, the actual sensitivity at the input does not change; the voltage values used on the display (V/div, offset, marker values, trigger level, automatic measurements) are adjusted to reflect the attenuation factor.

The default value for the **Probe** field is 10:1 for 10:1 divider probes.

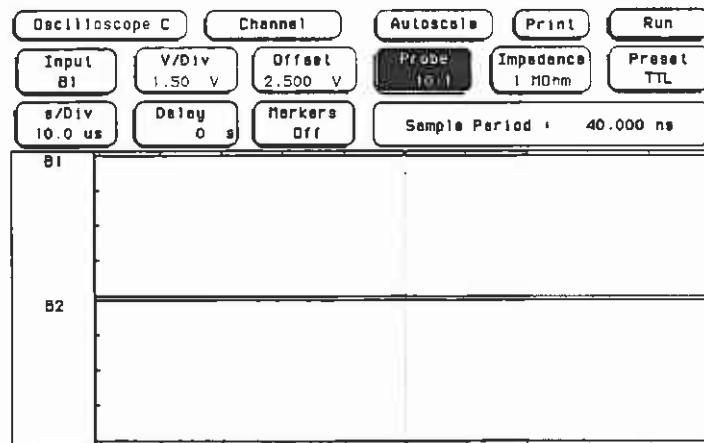

Impedance Field

The **Impedance** field sets the input impedance for the channel or external trigger selected in the **Input** field. When the **Impedance** field is touched, the Input impedance will toggle between **1 MOhm** (dc) and **50 Ohms** (dc). No pop-up keypad is available for this field.

The default value for the **Impedance** field is **1 MOhm**.

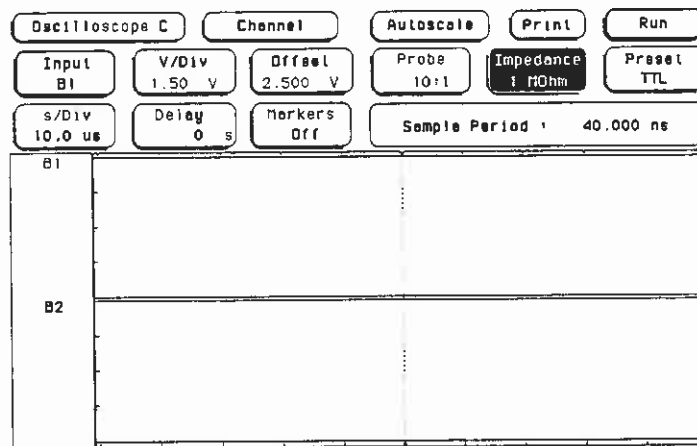

Preset Field

The **Preset** field automatically sets offset, V/div, and trigger level values to properly display TTL and ECL logic levels.

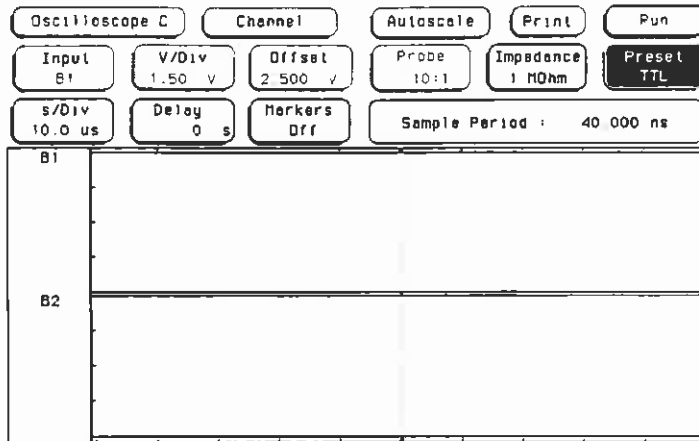

When you touch the **Preset** field, a pop-up appears as shown below.

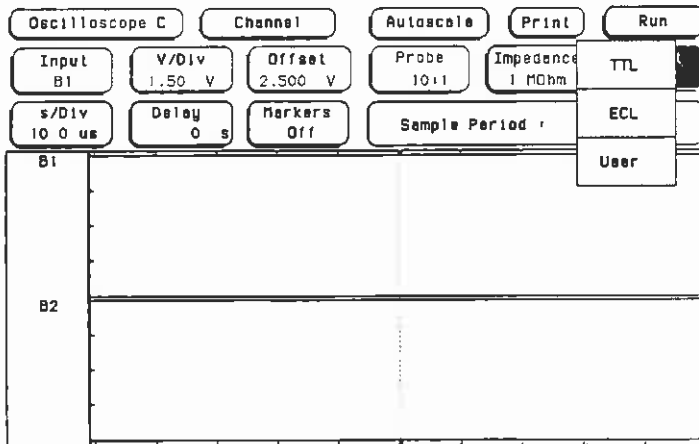

When you select TTL or ECL, the following values are set:

Parameter	Preset Value	
	ECL	TTL
V/Div	500 mV	1.5 V
Offset	-1.000 V	2.5 V
Trig Level	-1.300 V	1.380 V

When any of these values are changed from the preset value, the **Preset** field will change to **User** defined. If **User** is selected from the pop-up, no values will be changed.

The default value for the **Preset** field is **TTL**.

5

Timebase Functions

Introduction

The **s/Div** and **Delay** timebase functions control the horizontal display on the oscilloscope. **s/Div** and **Delay** are displayed in the bottom row of fields and are displayed on all oscilloscope menus except **Calibration**. These fields as they appear on the **Channel** menu are shown below.

Instrument Setup

Set up the oscilloscope as described below. This setup will be used throughout this chapter.

1. Connect a BNC cable from the COMPENSATION SIGNAL output on the timebase board to INPUT 1 on an acquisition board.
2. Turn the power on to the instrument.
3. Touch the **System** module field and select **Oscilloscope** from the pop-up.
4. Touch the **Autoscale** field to autoscale the signal.
5. Touch the **Run** field and drag your finger to the **Repetitive** field in the pop-up.

The display should now look like this:

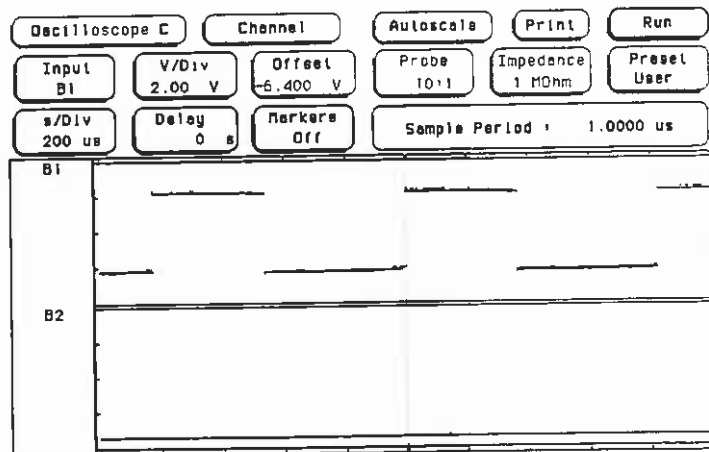

s/Div Field

The **s/Div** field sets the sweep speed or time scale on the horizontal axis of the display and is measured in seconds/division. The display is divided into 10 horizontal divisions. The divisions are marked by small tan tick marks at the top and bottom of the waveform display.

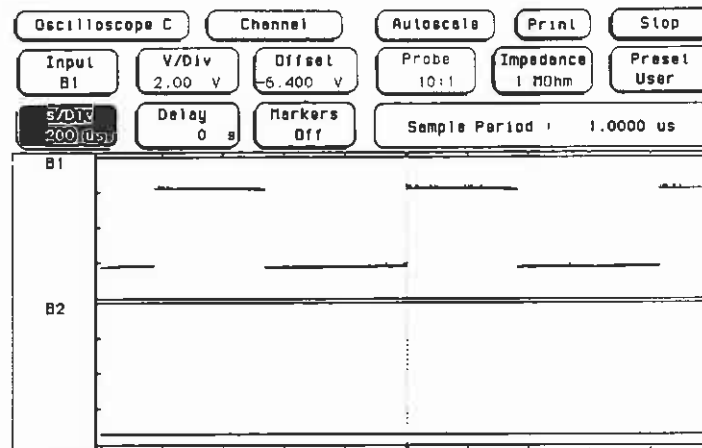

When the **s/Div** field is selected, the sweep speed can be changed by turning the knob. As the sweep speed is changed, the signal expands and compresses in both directions from the center of the display. As you turn the knob, the sweep speed changes in a 1-2-5 sequence from 5 ns/div to 10 s/div.

Sweep speed can also be entered from the pop-up keypad. The keypad will appear when you touch the **s/Div** field when the field is light blue. Any value from 5 ns/div to 10 s/div can be entered from the keypad. Sweep speed can be set to three-digit resolution. For example, if you entered a value of 15.45 ns, the value would be rounded up to 15.5 ns.

At sweep speeds 100 ms/div and slower, the time to acquire the 4096 sample points for acquisition memory is greater than 1 second. At these sweep speeds the screen will display **Waiting for Prestore** when acquiring the 2048 sample points prior to the delay time setting and **Waiting for Poststore** when acquiring the 2048 sample points after the delay time setting. This advises you the oscilloscope is still actively acquiring data. Acquisition times, which is memory depth in time, is shown in table 5-1 later in this chapter.

The default value for the s/Div field is 10 μ s.

**Zoom
(Acquisition
Stopped)**

If acquisitions have been stopped (see chapter 8), the oscilloscope uses the 4096 sample points stored in acquisition memory to display the new data on screen when the sweep speed is changed. This function would normally be used to zoom in or zoom out on a waveform acquired in **Single** (single-shot) mode. Zooming either expands or compresses the waveform horizontally and is changed by adjusting the s/Div field.

Zoom Example. Touch the s/Div field and turn the knob to set the sweep speed to 200 μ s/div, then touch the **Stop** field to stop acquisitions. Now turn the knob to change the sweep speed and notice how the acquired waveform expands and compresses.

Normally 500 points of the 4k waveform record is displayed on screen. Change the sweep speed to 500 μ s/div. Now all 4k of the waveform record is compressed and displayed on screen as shown below.

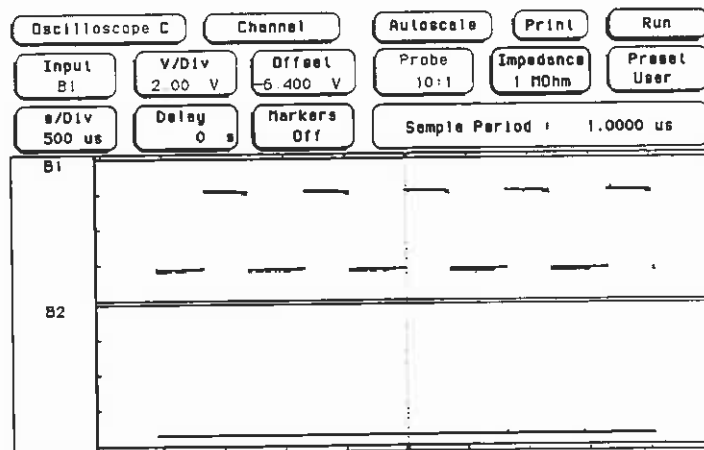

Now change the sweep speed to 2 us/div. At 200 us/div, 500 points were displayed on screen; at 2 us/div, only 5 points are displayed on screen. When the waveform is expanded, the oscilloscope uses a reconstruction filter to fill in the waveform points to provide a more useable display.

When used in conjunction with scrolling (see "Delay Field" paragraph), zooming is very useful in displaying single-shot waveforms.

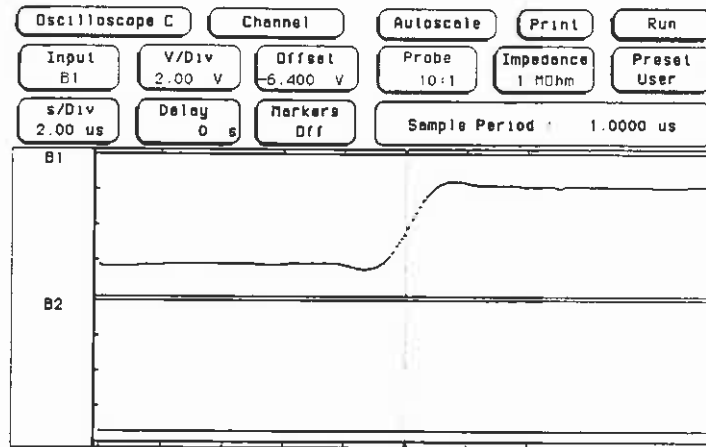

Delay Field

Delay time is the time offset before or after the trigger point on the waveform and is always measured from the trigger point to the center of the screen. The dotted red line at the center of the display is the trigger point. When delay time is zero, the trigger point is at the center of the screen.

When the **Delay** field is selected, the delay time can be changed by turning the knob. Remember that the trigger point is always delay time zero and is marked by the dotted red line. When the trigger point moves to the right side of the screen, the delay time is negative. This means that what you are viewing at center screen is before the trigger point and is referred to as negative time.

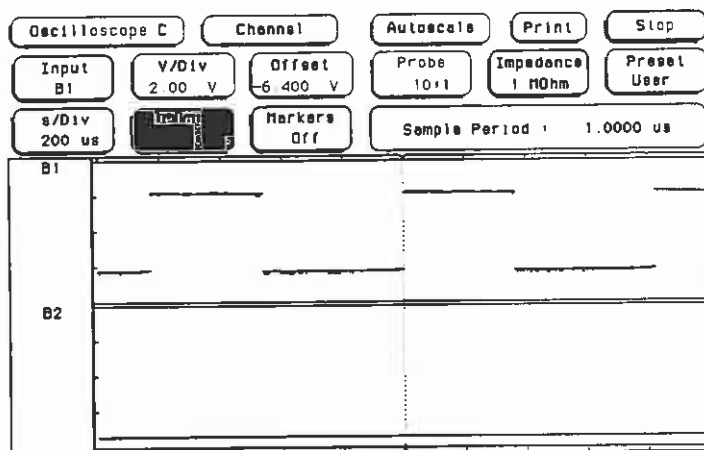

When the trigger point is moved to the left side of the screen, the delay time is positive and what you are viewing at center screen is after the trigger point.

Delay time resolution is equal to 2% of the sweep speed setting when using the knob. When using the pop-up keypad, resolution is 10 ps at sweep speeds of 99.99 ns/div and faster, and can be set to 5-digit resolution at sweep speeds of 100 ns/div and slower.

When run mode is set to **Repetitive**, the valid **Delay** range is:

Pre-trigger delay range = 4096 X sample rate

Post-trigger delay range = 5000 X sweep speed

Pre- and post-trigger delay time range is given for sweep speeds in table 5-1.

The default value for the **Delay** field is 0 s.

**Scrolling
(Acquisition
Stopped)**

If acquisitions have been stopped (see chapter 8), the **Delay** field controls the portion of the acquisition memory displayed on screen. When acquisition has been stopped:

- Pre-trigger delay range = delay time setting - (2048 X sample rate)
- Post-trigger delay range = delay time setting + (2048 X sample rate)

This means that one-half of data stored in acquisition memory is before the delay time setting and one-half of the data in memory is after the delay time setting.

This function would normally be used to scroll through a waveform acquired in **Single** (single-shot) mode. Scrolling allows you to view the entire waveform record by adjusting the **Delay** field.

Scroll Example. Touch the **s/Div** field and turn the knob to set the sweep speed to 200 $\mu\text{s}/\text{div}$, then touch the **Stop** field to stop acquisitions. Touch the **Delay** field and turn the knob to change the delay time to approximately -1.5 ms. As shown below, you are now looking at the beginning of the waveform record. You can now scroll through the entire 4k waveform record, both before and after the trigger point. When used in conjunction with zooming (see "**s/Div** Field" paragraph), scrolling is very useful in displaying single-shot waveforms.

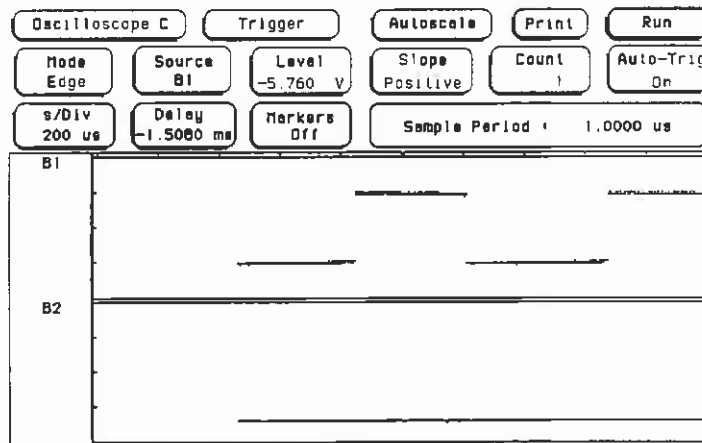

Table 5-1. Pre-trigger and Post-trigger Delay Range

Sweep Speed	Sample Period	Sample Rate*	Pre-trigger Range	Post-trigger Range	Memory Depth
5 ns/div	2.5 ns	400 Msa/s	10.240 us	25 us	10.240 us
10 ns/div	2.5 ns	400 Msa/s	10.240 us	50 us	10.240 us
20 ns/div	2.5 ns	400 Msa/s	10.240 us	100 us	10.240 us
50 ns/div	2.5 ns	400 Msa/s	10.240 us	250 us	10.240 us
100 ns/div	2.5 ns	400 Msa/s	10.240 us	500 us	10.240 us
200 ns/div	2.5 ns	400 Msa/s	10.240 us	1 ms	10.240 us
500 ns/div	2.5 ns	400 Msa/s	10.240 us	2.5 ms	10.240 us
1 us/div	2.5 ns	400 Msa/s	10.240 us	5 ms	10.240 us
2 us/div	5 ns	200 Msa/s	20.480 us	10 ms	20.480 us
5 us/div	20 ns	50 Msa/s	81.920 us	25 ms	81.920 us
10 us/div	40 ns	25 Msa/s	163.84 us	50 ms	163.84 us
20 us/div	100 ns	10 Msa/s	409.60 us	100 ms	409.60 us
50 us/div	200 ns	5 Msa/s	819.20 us	250 ms	819.20 us
100 us/div	400 ns	2.5 Msa/s	1.6384 ms	500 ms	1.6384 ms
200 us/div	1 us	1 Msa/s	4.0960 ms	1 s	4.0960 ms
500 us/div	2 us	500 ksa/s	8.1920 ms	2.5 s	8.1920 ms
1 ms/div	4 us	250 ksa/s	16.384 ms	5 s	16.384 ms
2 ms/div	10 us	100 ksa/s	40.960 ms	10 s	40.960 ms
5 ms/div	20 us	50 ksa/s	81.920 ms	25 s	81.920 ms
10 ms/div	40 us	25 ksa/s	163.84 ms	50 s	163.84 ms
20 ms/div	100 us	10 ksa/s	409.60 ms	100 s	409.60 ms
50 ms/div	200 us	5 ksa/s	819.20 ms	250 s	819.20 ms
100 ms/div	400 us	2.5 ksa/s	1.6384 s	500 s	1.6384 s
200 ms/div	1 ms	1 ksa/s	4.0960 s	1 ks	4.0960 s
500 ms/div	2 ms	500 sa/s	8.1920 s	2.5 ks	8.1920 s
1 s/div	4 ms	250 sa/s	16.384 s	2.5 ks	16.384 s
2 s/div	10 ms	100 sa/s	40.960 s	2.5 ks	40.960 s
5 s/div	20 ms	50 sa/s	81.920 s	2.5 ks	81.920 s
10 s/div	40 ms	25 sa/s	163.84 s	2.5 ks	163.84 s

* sa/s = samples/second

Sample Period Display

Any time the **Markers** field is **Off**, the sample period of the acquired waveform is displayed in the bottom row of the menu fields. Sample period is the time period between acquired sample points and is the inverse of sample rate (digitizing rate). Sample period is a function of sweep speed and can only be changed by changing the **s/Div** field. Sample period and sample rates for sweep speeds in shown in table 5-1.

6

Trigger Menu

Introduction

The **Trigger** menu controls the selection of trigger modes for the oscilloscope. The **Trigger** menu has three modes:

- Edge
- Pattern
- Immediate

When the oscilloscope is powered up, the default trigger mode is **Edge**.

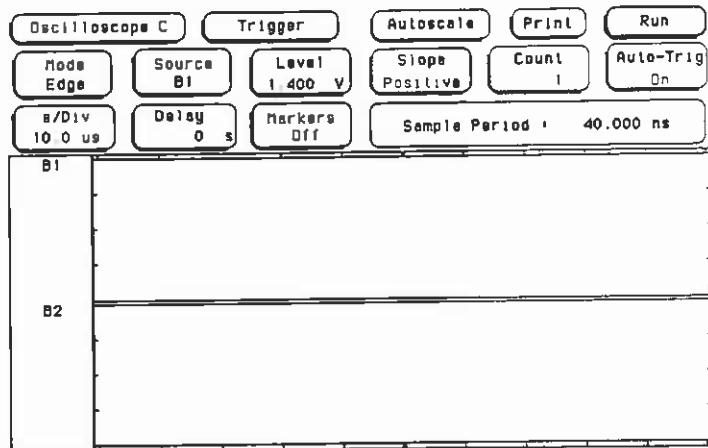

Trigger Menu Map The menu map for the Trigger menu is shown below.

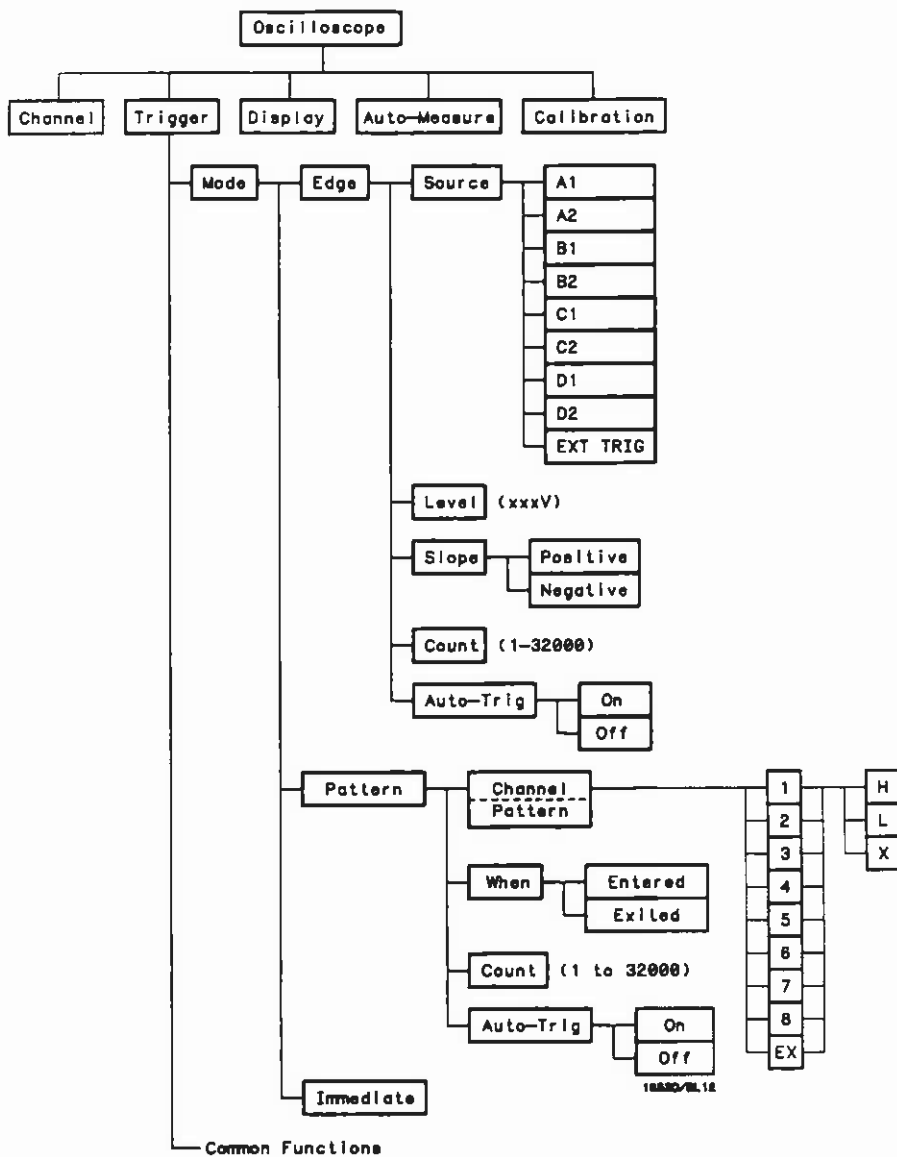

Mode Field

The **Mode** field selects the trigger mode for the oscilloscope. When you touch the **Mode** field, a pop-up appears showing the three trigger modes: edge, pattern, and Immediate. To select a trigger mode, touch any selection in the pop-up field.

The default selection for the **Mode** field is **Edge**.

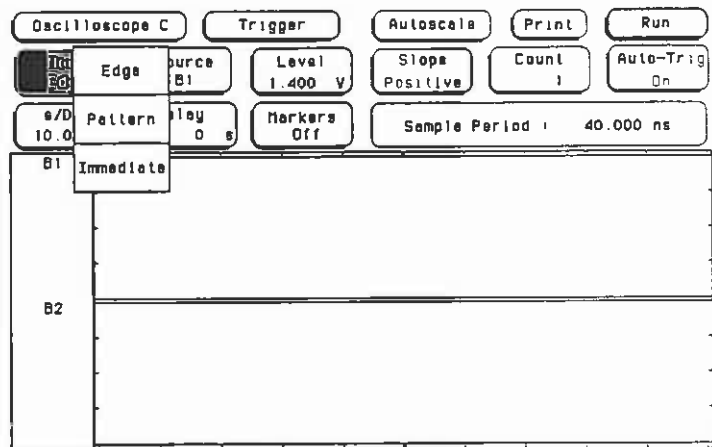

Trigger Marker

The trigger marker is the dotted vertical red line at the center of the waveform display. The point where the waveform from the trigger source or trigger condition crosses the trigger marker is called the trigger point and always represents delay time of zero seconds.

If delay time is set to greater than ± 5 times the sweep speed, the trigger marker will be moved off screen.

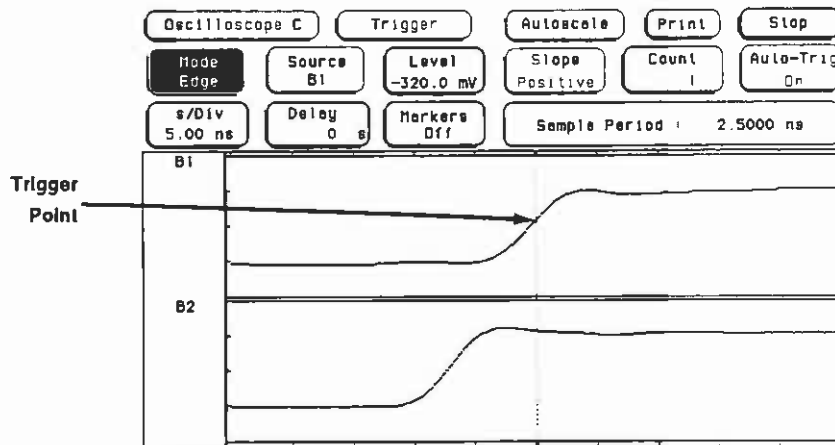

Immediate Trigger Mode

Immediate trigger mode causes the oscilloscope to trigger by itself. When you touch the **Mode** field, **Immediate** can be selected from the pop-up field. The default immediate trigger menu is shown below.

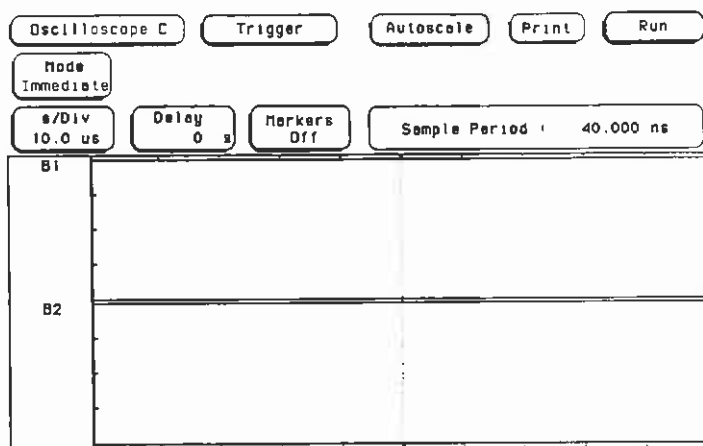

If the oscilloscope module is set to **Independent** in the **Intermodule** module menu, the oscilloscope will be in the free-run mode and the waveform display will not be synchronized to a trigger point.

If the oscilloscope module is set to **Group Run** in the **Intermodule** module menu, the oscilloscope triggers itself as soon as it is armed by the input port or another module from the **Intermodule** menu.

Immediate trigger mode can be used for dual timebase applications when one oscilloscope module arms another oscilloscope module, or another module such as a logic analyzer could arm the oscilloscope. More information about intermodule applications can be found in the *HP 16500A Logic Analysis System Reference Manual*.

Edge Trigger Mode

Edge trigger is the type of triggering found in all oscilloscopes. In edge trigger mode the oscilloscope triggers at a specified voltage level on a rising or falling edge of one the input channels or external trigger input. In this mode you can specify which input is the trigger source, set a trigger level voltage, and specify which edge to trigger on.

Source Field The trigger source can be set to any input signal. When you touch the **Source** field, a pop-up appears showing the inputs available as the trigger source. The source can be input A1, A2, B1, B2, C1, C2, D1, D2, or external trigger (EXT TRIG) input. The inputs that appear in the **Source** field pop-up are dependent upon how many acquisition cards are installed in the mainframe and which slots they are installed in. The minimum sources displayed would be two channel inputs and external trigger as shown below.

The default selection for the **Source** field is the lowest letter/number input channel. For example, if acquisition cards were installed in mainframe slots A, B, and C, the **Source** field would default to A1.

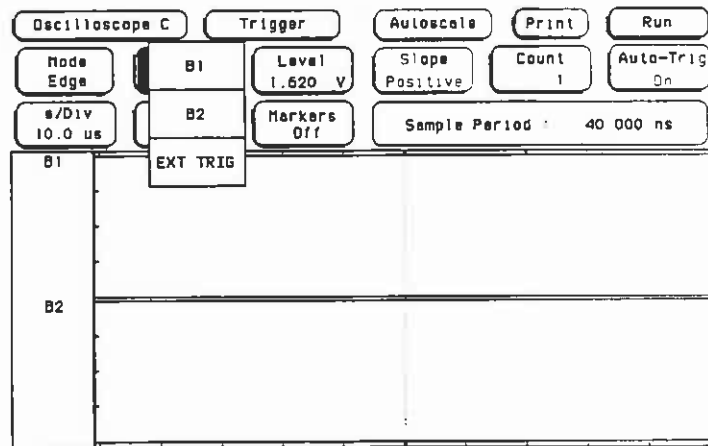

Level Field The voltage level at which the trigger source waveform crosses the trigger marker is set by the **Level** field. When the **Level** field is selected, the trigger level can be changed by turning the knob. When the trigger level is changed, the waveform moves on the display to maintain the trigger point (where the waveform edge crosses the trigger level line). If the trigger level is set above or below the waveform, trigger is lost and the waveform display will be unsynchronized.

Trigger level can be set to any voltage value contained within the waveform display window in increments of 1% of full scale horizontal voltage range ($V/Div \times 4$). For example, if full scale voltage range were 400 mV, trigger level could be set in increments of 4 mV.

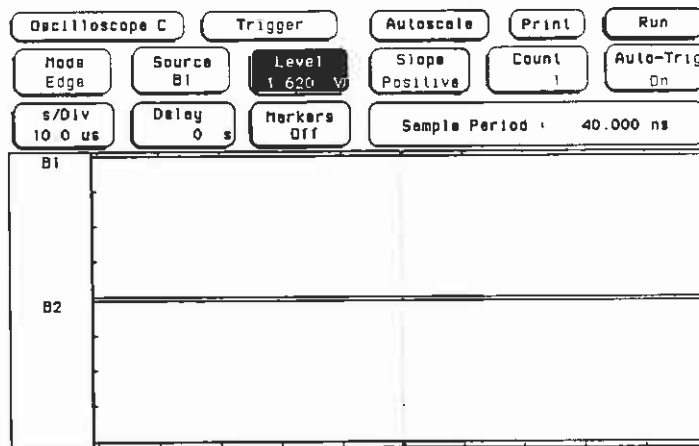

Trigger level can also be entered with the pop-up keypad. The keypad will appear when you touch the **Level** field when the field is light blue. Any value in 1% increments of full scale horizontal voltage range can be entered. Values entered that are not in this range will be rounded to the nearest 1% increment.

Since the trigger level range is limited by the voltage values displayed in the waveform window, the voltage window can be easily determined. Turn the knob in both directions until the **Level** field reads minimum and maximum voltage. These voltage values are the limits of the waveform window.

The default value for the **Level** field is 2.5 V (TTL preset value).

Slope Field You can set the trigger slope to trigger on either the positive or negative edge of the trigger source waveform. When the **Slope** field is touched, the field will toggle between **Positive** and **Negative**. No pop-up field is available for this field.

The default selection for the **Slope** field is **Positive**.

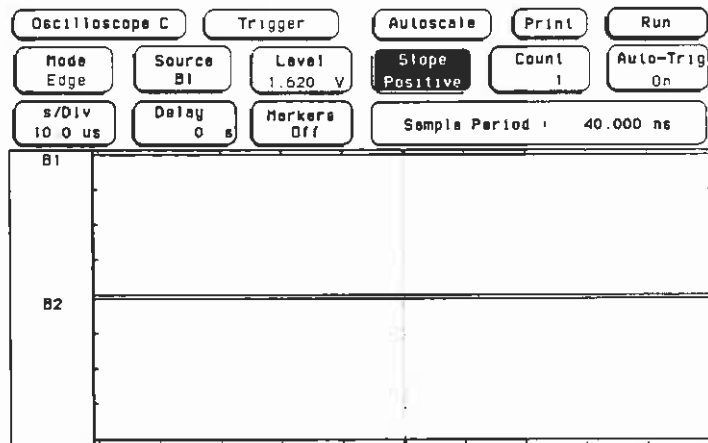

Auto-Trig Field

The **Auto-Trig** field lets you specify whether or not the acquisitions should wait for the specified trigger condition to occur. When the **Auto-Trig** field is touched, the field will toggle between **On** and **Off**. No pop-up field is available for this field.

On. When auto-trigger is set to on, the oscilloscope waits for 25 ms (40 Hz rate) for a trigger to occur. If a trigger does not occur within that time, whatever is in the acquisition memory is displayed and "Auto triggered" is displayed:

- If no signal is on the input, the oscilloscope will display a baseline.
- If there is a signal but the specified trigger condition has not been met within 25 ms, the waveform display will not be synchronized to a trigger point.

Off. When auto-trigger is set to off, the oscilloscope waits until a trigger is received before the waveform display is updated. If a trigger does not occur, the screen is not updated and "Waiting for Trigger" is displayed. Use this mode when:

- the trigger source signal is less than a 40-Hz repetition rate.
- the trigger events counter (see **Count** field) is set so that the number of trigger events would not occur before 25 ms.

The default selection for the **Auto-Trig** field is **On**.

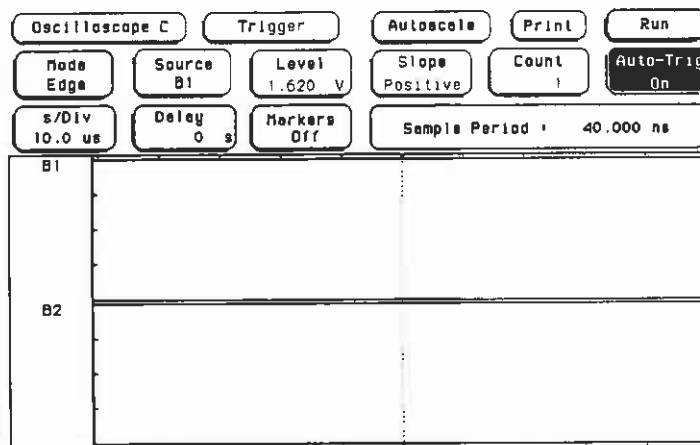

Count Field In edge trigger mode, you can define a positive or negative edge and trigger level as a trigger qualifier. When the oscilloscope detects the trigger qualifier, it will trigger after a user-defined number of edges (**Count** field) on any input.

The **Count** field defines the number of trigger events that must occur after the trigger qualifier before the oscilloscope will trigger and acquire a waveform.

Count can be set to any integer from 1 to 32000. The event number set by the **Count** field will be displayed at the trigger marker when the acquisition is displayed. When the **Count** field is selected, the trigger events count can be changed by turning the knob or by entering a value from the pop-up keypad.

This type of triggering is commonly referred to as "events triggering" or "delay-by-events triggering". It is very useful when trying to trigger on a specific pulse in a burst of pulses, with a long time delay before the next burst occurs.

The default value for the **Count** field is 1.

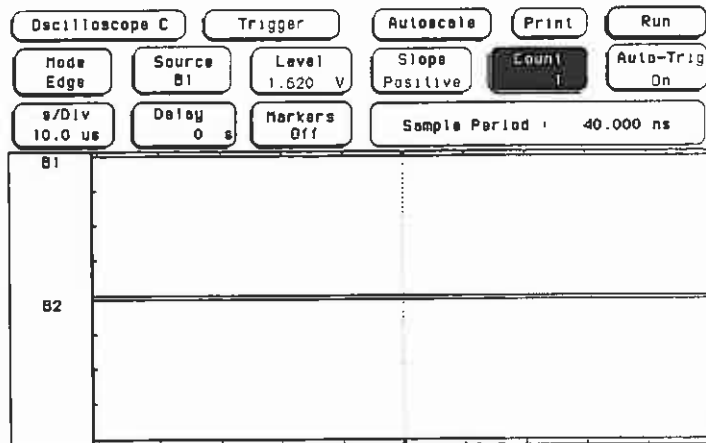

Pattern Trigger Mode

Pattern trigger mode allows you to trigger the oscilloscope upon entering or exiting a specified pattern of all the input channels and the external trigger input.

When you touch the **Mode** field, **Pattern** can be selected from the pop-up field. The default pattern trigger menu is shown below.

Oscilloscope C	Trigger	Autoscale	Print	Run
Mode Pattern	Channel: 12 Ex Pattern: XX X	When Entered	Count 1	Auto-Trig On
s/DIV 10.0 us	Delay 0 s	Markers Off	Sample Period : 40.000 ns	
B1				
B2				

Channel-Pattern Field The Channel-Pattern field allows you to enter a pattern for input channels and external trigger.

Channel. The Channel row of the field lists the inputs available in the mainframe. Channels are numbered from 1 through 8 and Ex for external trigger. The field will only display the actual number of input channels installed in the mainframe. The lowest channel number is assigned to the lowest letter/number combination input. For example, if acquisition cards were installed in mainframe slots B, C, and D:

- Channel 1 = B1
- 2 = B2
- 3 = C1
- 4 = C2
- 5 = D1
- 6 = D2
- Ex = EXT TRIG

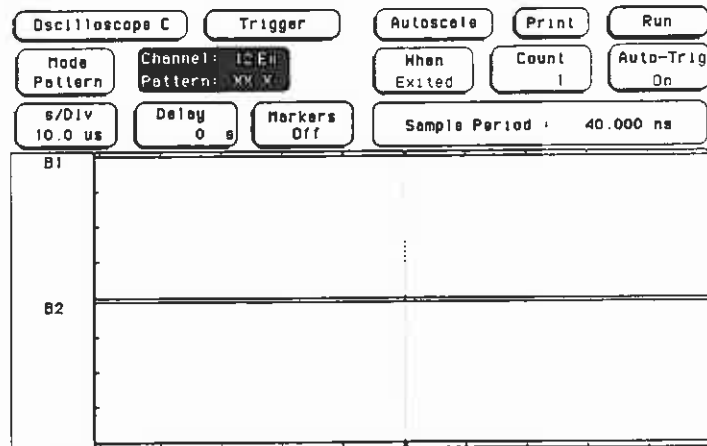

Pattern. The **Pattern** row of the field lists the trigger condition of the input above it in the **Channel** row.

Note

*You must set the trigger level for each input you want to use in the pattern by using the **Level** field in **Edge** trigger mode. This sets the threshold of each input for high and low levels in the pattern.*

The pattern for each input may be specified as high (H), low (L), or "don't care" (X).

H - the input channel's voltage must be greater than the edge trigger level of that input.

L - the input channel's voltage must be less than the edge trigger level of that input.

X - is a "don't care" condition. The associated input channel will not be used in the pattern for the trigger qualifier.

The default condition for all patterns is "don't care". To change the pattern, touch the **Channel-Pattern** field. A pop-up will appear which allows you to assign the pattern conditions.

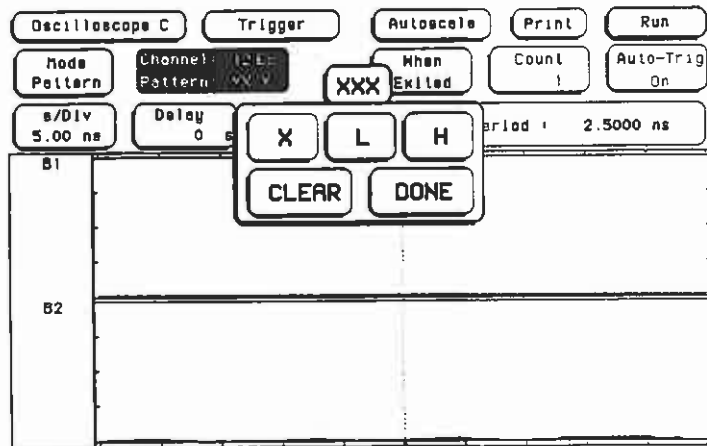

To enter a pattern, touch either **X**, **L**, or **H** on the pop-up. The entries appear at the top of the pop-up as they are entered. If you make a mistake, turn the knob to move the highlight to the entry to be corrected or touch **CLEAR** to change all entries back to **X**. If the pattern is correct, touch **DONE**.

When Field When this field is touched, it toggles between **When Entered** and **When Exited**.

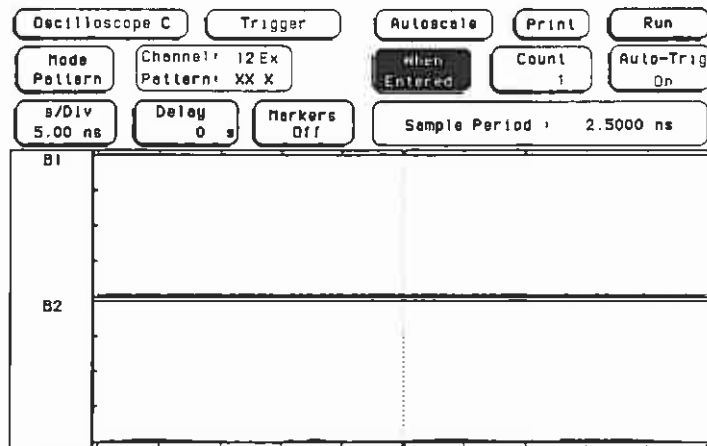

When Entered. The oscilloscope will trigger on the first transition that makes the pattern specification true for every input the number of times specified by the **Count** field.

When Exited. The oscilloscope will trigger on the first transition that causes the pattern specification to be false after the pattern has been true the number of times specified by the **Count** field.

The default selection for the **When** field is **When Entered**.

Auto-Trig Field The **Auto-Trig** field lets you specify whether or not the acquisitions should wait for the specified pattern condition to occur. When the **Auto-Trig** field is touched, the field will toggle between **On** and **Off**. No pop-up field is available for this field.

On. When auto-trigger is set to on, the oscilloscope waits for 25 ms (40 Hz rate) for a trigger to occur. If a trigger does not occur within that time, whatever is in the acquisition memory is displayed and "Auto triggered" is displayed:

- If no signal is on the input, the oscilloscope will display a baseline.
- If there is a signal but the specified pattern condition has not been met within 25 ms, the waveform display will not be synchronized to a trigger point.

Off. When auto-trigger is set to off, the oscilloscope waits until a trigger is received before the waveform display is updated. If a trigger does not occur, the screen is not updated and "Waiting for Trigger" is displayed. Use this mode when:

- the trigger source signal is less than a 40-Hz repetition rate.
- the trigger events counter (see **Count** field) is set so that the number of trigger pattern events would not occur before 25 ms.

The default selection for the **Auto-Trig** field is **On**.

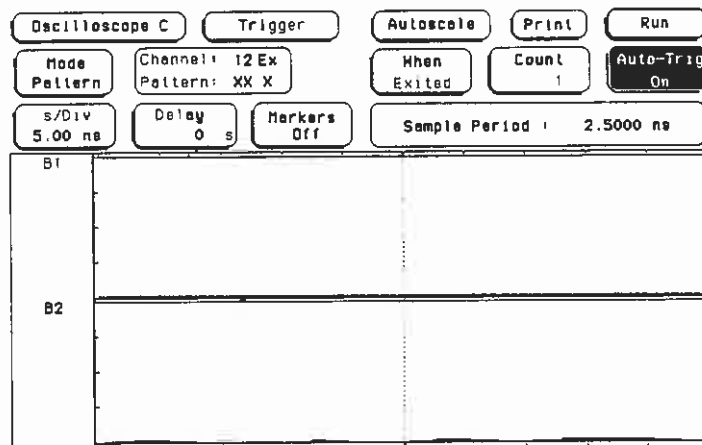

Count Field In pattern trigger mode, you can define a pattern as a trigger qualifier. When the oscilloscope detects the trigger qualifier, it will trigger after a user-defined number of patterns has occurred (**Count field**) on all inputs.

The **Count** field defines the number of pattern events that must occur after the trigger qualifier before the oscilloscope will trigger and acquire a waveform.

Count can be set to any integer from 1 to 32000. The event number set by the **Count** field will be displayed at the trigger marker when the acquisition is displayed. When the **Count** field is selected, the pattern events count can be changed by turning the knob or by entering a value from the pop-up keypad.

The default value for the **Count** field is 1.

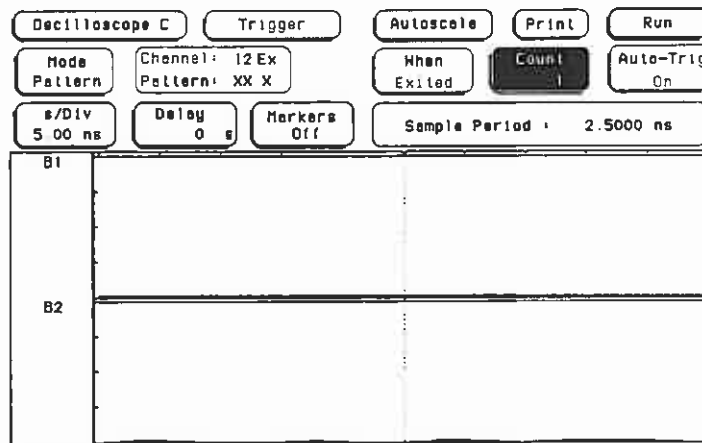

Pattern Trigger Exercise

This exercise demonstrates how the input signals can be used in a pattern combination to generate a trigger.

Connecting the Equipment

Connect one BNC tee adapter and two 1-metre BNC cables to the oscilloscope as shown below. Connecting the cables in this manner will delay the signal to INPUT 1 by a few nanoseconds. This will allow you to set up different pattern trigger combinations.

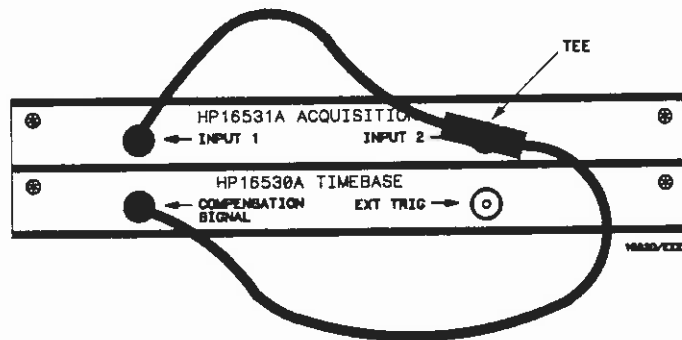

Setting Up the Oscilloscope

1. Turn the power on to the instrument.
2. Touch the **System** module field and select **Oscilloscope** from the pop-up.
3. From the default oscilloscope **Channel** menu, make the following changes:
 - Input 1 **Probe** field to **1:1**
 - Input 1 **Impedance** field to **50 Ohms**
 - Input 2 **Probe** field to **1:1**
 - Input 2 **Impedance** field remains at **1 MOhm**
4. Touch the **Autoscale** field to autoscale the signal.
5. Touch the **Run** field and drag your finger to the **Repetitive** field in the pop-up.
6. Set the **s/Div** field to **5.00 ns**.

The oscilloscope display should now look like this:

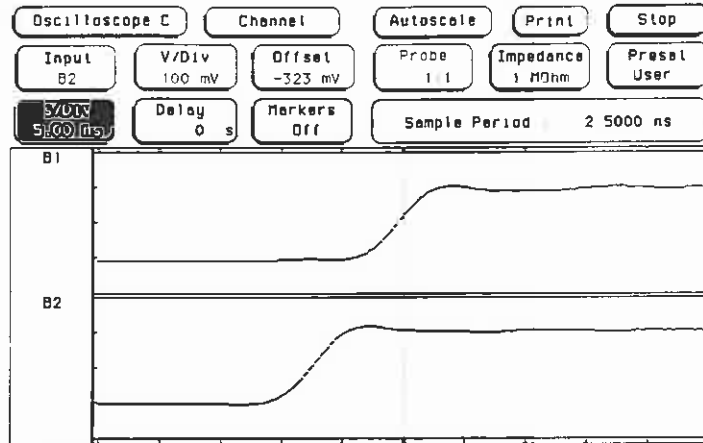

Touch the **Channel** menu field and select **Trigger** from the pop-up. Touch the **Mode** field and select **Pattern** from the pop-up. The display will not be synchronized to a trigger point at this time because all of the **Channel-Pattern** terms are set to X ("don't cares").

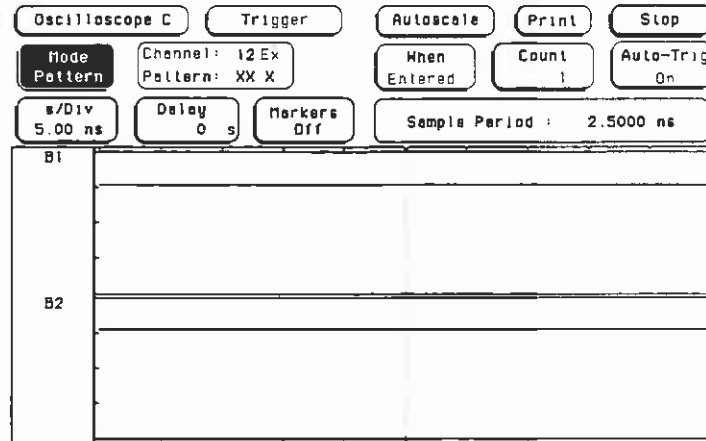

Entering a Trigger Pattern

The Channel-Pattern field shows the inputs available and the pattern assigned to each input. At this point, input 1, input 2, and external trigger (Ex) are assigned "don't cares". Touch the Channel-Pattern field. A pop-up appears as shown below.

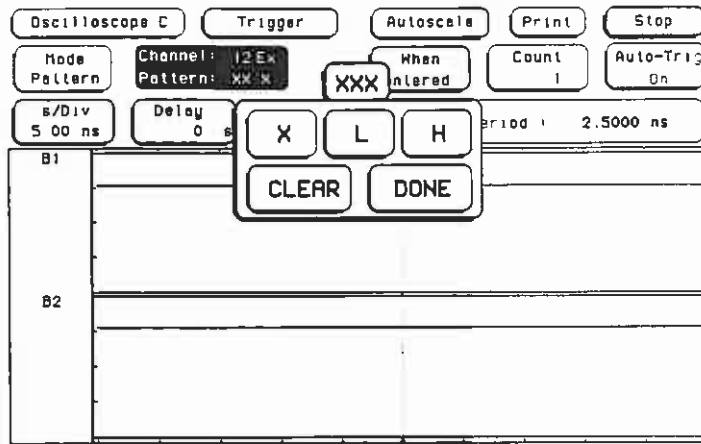

Change the pattern to HHX by touching H, H, then X in the pop-up. The letters appear at the top of the pop-up as they are entered. If you make a mistake, turn the knob to move the highlight to the entry to be corrected, or touch CLEAR to change all entries back to X and start over again. When the pattern is entered correctly, touch DONE to return to the pattern trigger menu.

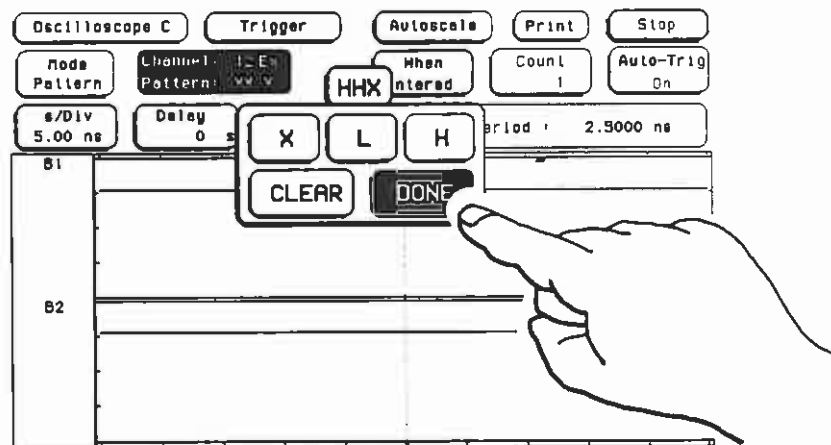

The waveform display should now look like this. The **When** field is set to **Entered** so the oscilloscope is triggering on the first transition that makes the pattern specification true for input 1 and input 2 (external trigger is "don't care"). Input 2 is high first, then the trigger occurs as input 1 crosses above its trigger threshold.

Note

*The trigger level for each input in the pattern specification must be set using the **Level** field in **Edge** trigger mode. This sets the threshold of each input for high and low levels in the pattern. In this exercise, input 1 and input 2 trigger levels were set to the correct levels by using **Autoscale**.*

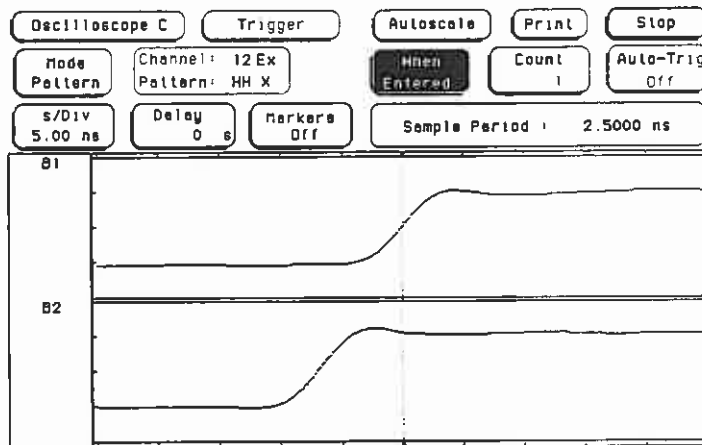

Touch the **When Entered** field to toggle to **When Exited**. The waveform should now look like the one at the top of the next page. The oscilloscope is triggering on the first transition that causes the pattern specification to be false after the pattern has been true one time (**Count=1**). At the beginning of the waveform trace, Input 1 and input 2 are high and the pattern specification is true. When Input 2 crosses below its trigger threshold, the pattern becomes false and the oscilloscope triggers.

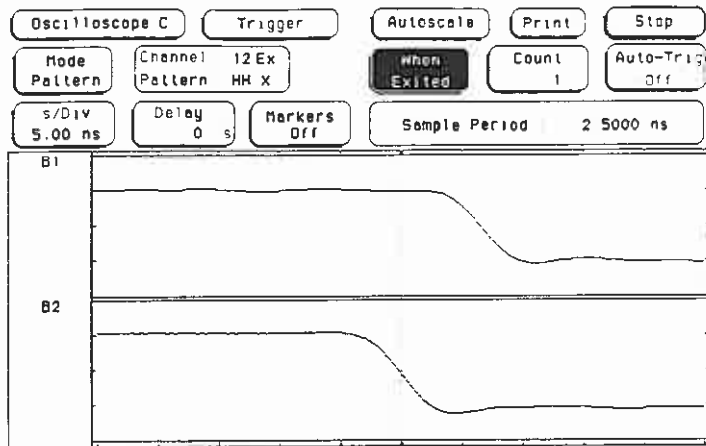

Change the **Channel-Pattern** field to LHX. The waveform display should now look like this. Approximately 7 ns before the trigger marker Input 1 is low, input 2 crosses above its trigger threshold, and the pattern specification becomes true. At the trigger marker, Input 1 crosses above its trigger threshold and the pattern specification becomes false. At this point the trigger occurs because the oscilloscope was set to trigger when the pattern was **Exited**.

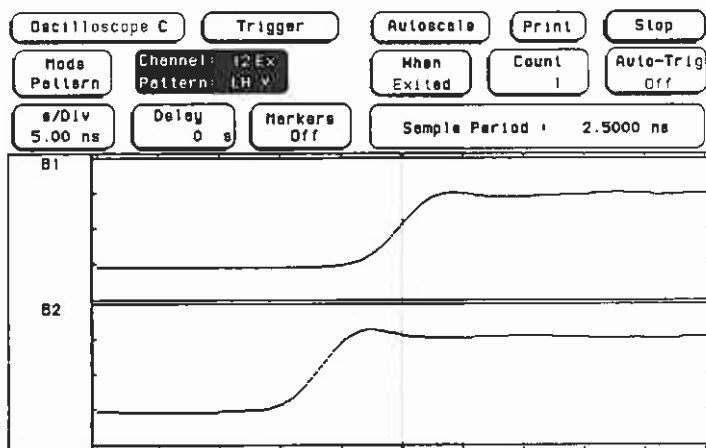

7

Autoscale

Autoscale Field

Autoscale is a function built into the digitizing oscilloscope that automatically displays one or more waveforms. The **Autoscale** field is displayed in the top row of menu fields on every oscilloscope menu.

Oscilloscope C		Channel		Autoscale	Print	Run
Input B1	V/Div 1.50 V	Offset 2.500 V	Probe 10:1	Impedance 1 M Ω m	Preset TTL	
s/Div 10.0 μ s	Delay 0 s	Markers Off	Sample Period : 40.000 ns			
B1						
B2						

When the **Autoscale** field is touched, a pop-up appears allowing you to cancel or continue the autoscale. If you accidentally touch the **Autoscale** field, touching the **Cancel** field will cancel autoscale to keep you from inadvertently changing your oscilloscope setup.

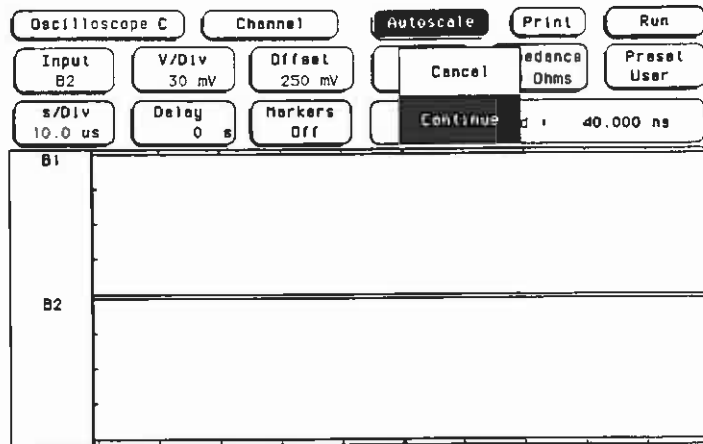

If the **Continue** field is touched, the autoscale function is started and the advisory **Autoscale in progress** is displayed. The oscilloscope automatically sets **V/Div** (vertical sensitivity), channel **Offset**, **s/Div** (sweep speed), and trigger **Level** so that the input signals are displayed on screen. The oscilloscope checks all vertical inputs and looks for the trigger on the input channel with the lowest number. The following fields are changed when autoscale is complete:

Channel menu

- V/Div** - scaled
- Offset** - scaled

Trigger menu

- Mode** - Edge
- Source** - set to lowest number input with signal present
- Level** - scaled
- Slope** - Positive
- Count** - 1
- Auto-Trig** - On

Any menu

- s/Div** - scaled
- Delay** - 0 s

When a Signal is Found

If a signal is found on any of the vertical inputs, the oscilloscope determines the frequency of the signals and automatically scales the vertical sensitivity, offset, sweep speed, and trigger level to display the waveform on screen. The oscilloscope will normally display between 1 and 3 complete cycles of the waveform.

If a signal is present at more than one input, the trigger source is always assigned to the signal input with the lowest number. This input is also used to scale the sweep speed. If only one vertical input has a signal present, that signal is the trigger source. The trigger point on the waveform is displayed as a dotted vertical red line at the center of the screen (**Delay = 0 s**).

When autoscaling is complete, the display should look something like this:

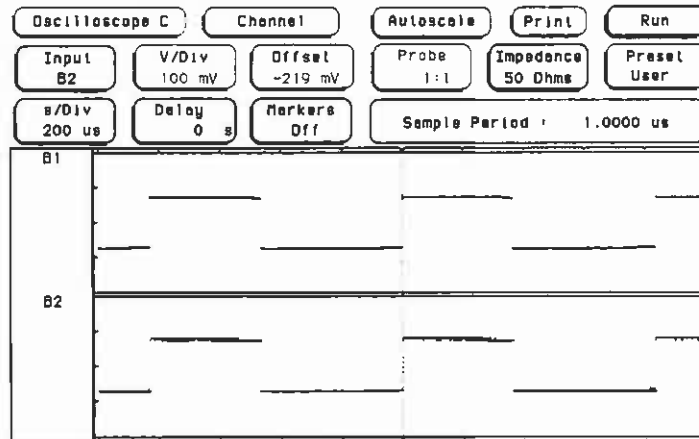

If No Signal is Found

If no signal is found on any of the vertical inputs, the oscilloscope displays the advisory **No signal found**, then displays **Auto Triggered**, and the oscilloscope is placed in an auto-trigger mode. The auto-trigger mode allows the oscilloscope to auto-sweep and display a baseline anytime a trigger signal is not present.

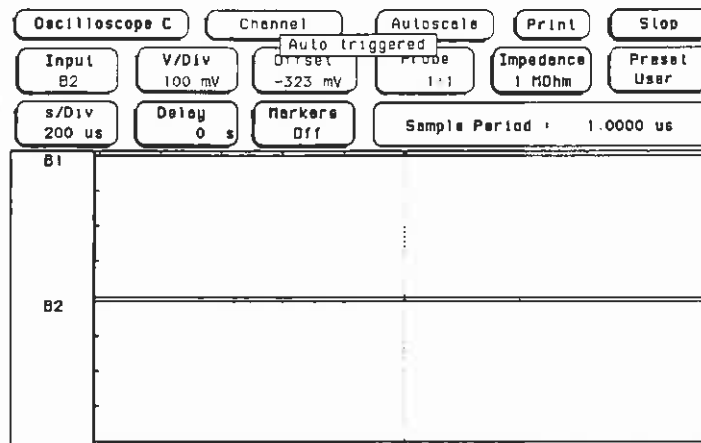

8

Running the Oscilloscope

Introduction

The oscilloscope module is a 400-megasample/second, real-time digitizing oscilloscope with 100-MHz bandwidth. Each 4k-sample waveform record is acquired on a single acquisition. Multiple channels (2, 4, 6, or 8) are acquired simultaneously so you can determine relationships between infrequent events. For more information on real-time sampling, refer to chapter 4 of the book *Feeling Comfortable with Digitizing Oscilloscopes*.

Run/Stop Field

The Run/Stop field controls how the oscilloscope acquires waveform data. The field is in the upper-right corner of all oscilloscope menus as shown below. The oscilloscope can acquire waveforms in **Single** (single-shot) mode or in **Repetitive** mode. **Single** mode acquires a waveform on a single acquisition and then stops running. **Repetitive** mode acquires a waveform on a single acquisition, then updates the display each time a new acquisition is made. **Repetitive** mode continues acquiring data in this manner until stopped by the user. Each 4k-sample waveform record is acquired in a single acquisition in both **Single** and **Repetitive** mode.

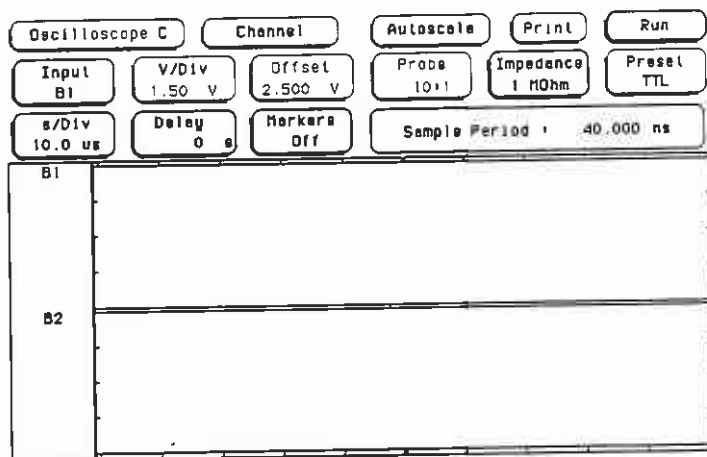

When the green **Run** field is displayed, the oscilloscope is stopped and touching the **Run** field will start the oscilloscope running. When the red **Stop** field is displayed, the oscilloscope is running and touching the **Stop** field will stop the oscilloscope.

When powered on, the oscilloscope defaults to the **Single** mode.

Single Mode

When the mainframe is first powered up, none of the modules installed in the mainframe are running. This prevents any unwanted interaction between the modules.

To start the oscilloscope running in the single-shot mode, touch the green **Run** field, then slide your finger down to the **Single** field in the pop-up until the **Single** field turns white. Then remove your finger from the screen. If the **Cancel** field in the pop-up is selected, the oscilloscope would return to the state it was in before the **Run** field was touched.

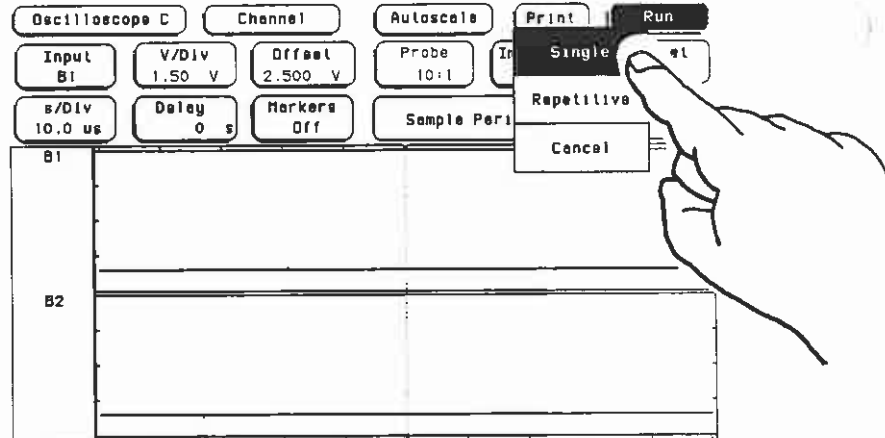

This starts the oscilloscope running in the **Single** mode. When the single-shot acquisition is being made, the **Run/Stop** field will display **Stop**. When the acquisition is completed, the field will display **Run**. In this mode, the oscilloscope makes a single acquisition, displays the results, then waits until the **Run** field is touched again before making another acquisition.

Repetitive Mode

To start the oscilloscope running in the repetitive mode, touch the green **Run** field, then slide your finger down to the **Repetitive** field in the pop-up until the **Repetitive** field turns white. Then remove your finger from the screen. If the **Cancel** field in the pop-up is selected, the oscilloscope would return to the state it was in before the **Run** field was touched.

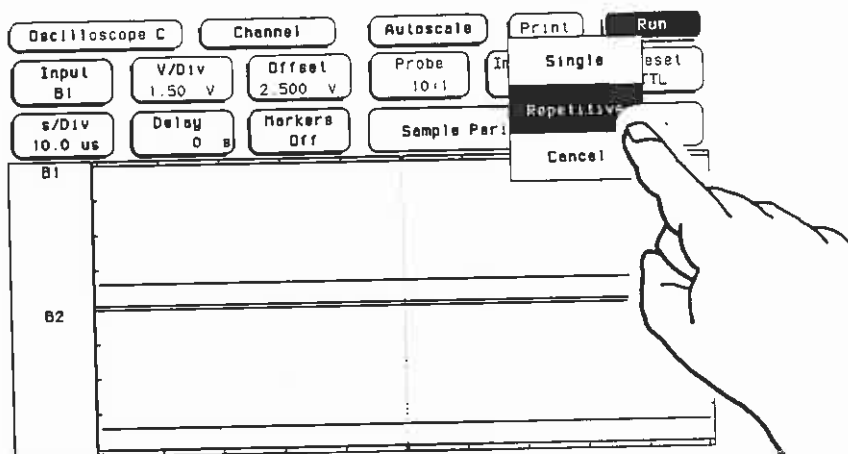

This starts the oscilloscope running in the **Repetitive** mode. In this mode, the display is updated each time a new acquisition is made. While the real-time repetitive acquisitions are being made the **Run/Stop** field will display **Stop**. When you want to stop making repetitive acquisitions, touch the **Stop** field. To resume making repetitive acquisitions, touch the **Run** field again.

Reminder

Remember, when the **Run/Stop** field displays **Run**, the oscilloscope is stopped and touching the **Run** field will start the oscilloscope running. Likewise, when the **Run/Stop** field displays **Stop**, the oscilloscope is running and touching the **Stop** field will stop the oscilloscope.

9

Marker Measurements

Introduction

In addition to automatic parametric measurements, the oscilloscope also has two markers for making time and voltage measurements either manually or automatically. These markers are accessed by touching the **Markers** field on any of the oscilloscope menus except **Calibration**.

The default selection for the **Markers** field is **Off**.

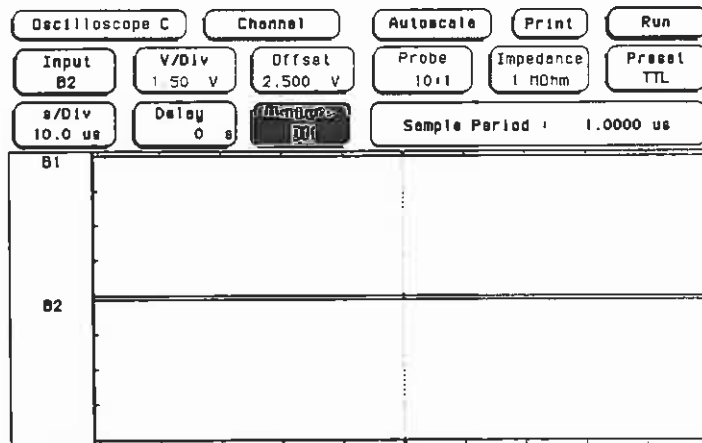

Markers Field Menu Map

The menu map for the Markers field is shown below.

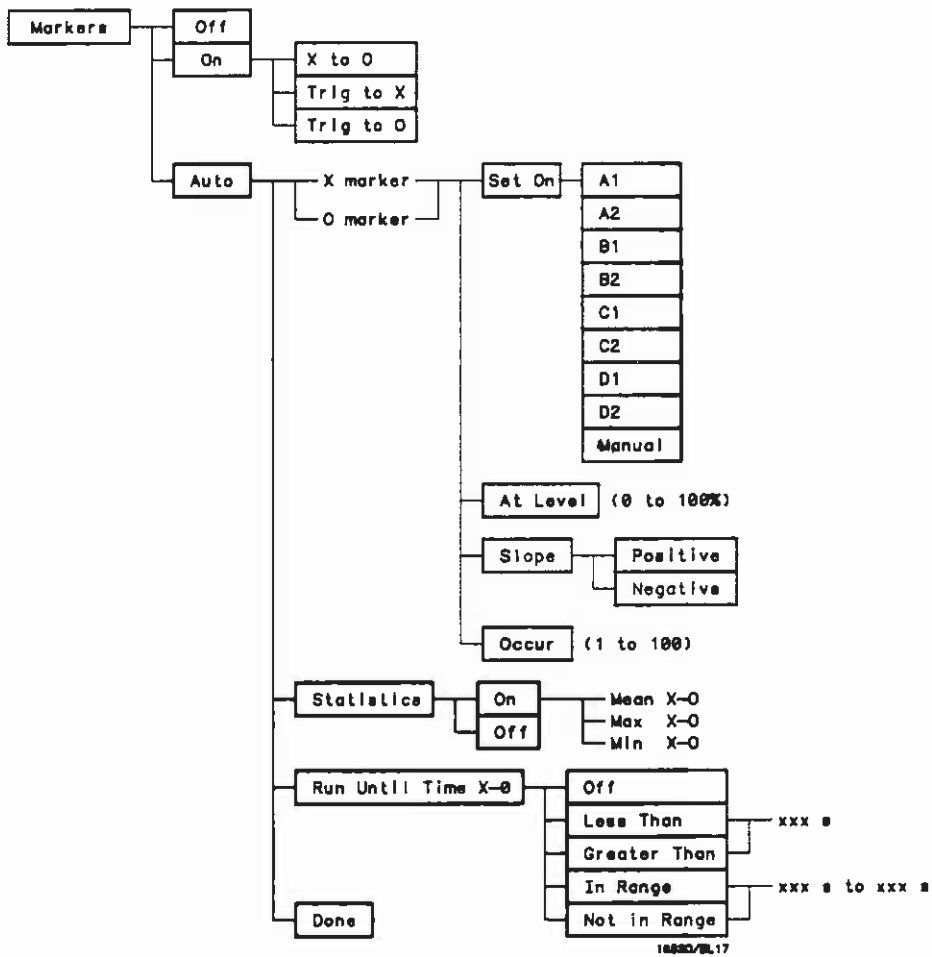

Marker Measurements

To demonstrate how to make marker measurements, set up the oscilloscope as described below. This setup will be used throughout the remainder of this chapter.

Connecting the Equipment

Connect one BNC tee adapter and two 1-metre BNC cables to the oscilloscope as shown below.

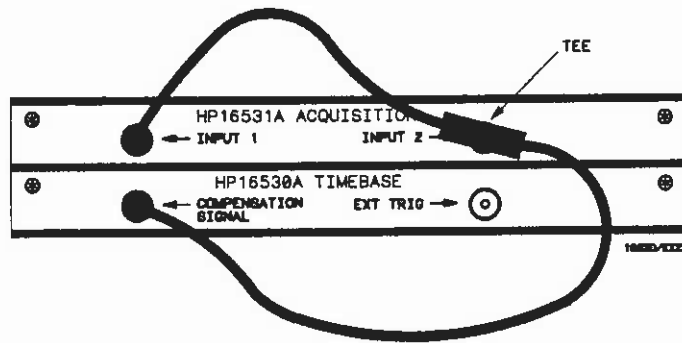

Setting Up the Oscilloscope

1. Turn the power on to the Instrument.
2. Touch the **System** module field and select **Oscilloscope** from the pop-up.
3. From the default oscilloscope **Channel** menu, make the following changes:
 - Input 1 **Probe** field to 1:1
 - Input 1 **Impedance** field to 50 Ohms
 - Input 2 **Probe** field to 1:1
 - Input 2 **Impedance** field remains at 1 MOhm
4. Touch the **Autoscale** field to autoscale the signal.
5. Touch the **Run** field and drag your finger to the **Repetitive** field in the pop-up.

6. The display should now look like this:

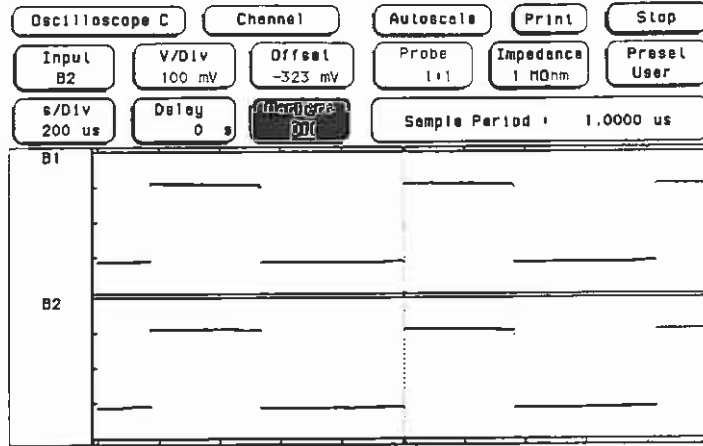

Manual Marker Measurements

Touch the **Markers** field on the display. When the pop-up appears, touch the **On** field. With **Markers** set to **On**, you can manually move the X and O markers to make time and voltage measurements.

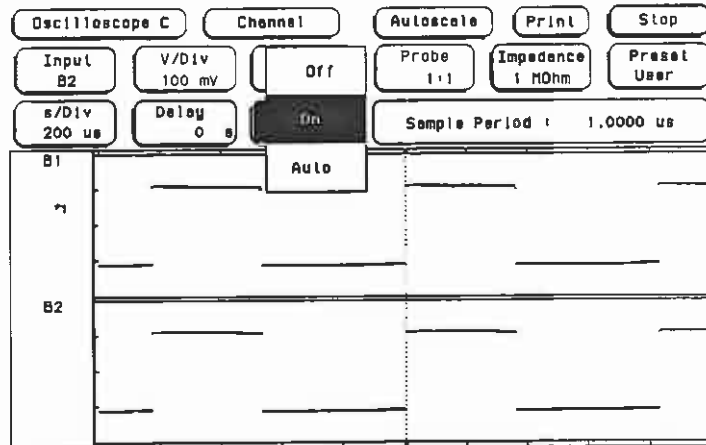

Three new fields will appear to the right of the **Markers** field: **X to O**, **Trig to X**, and **Trig to O** fields. These fields allow you to position an X marker and an O marker by entering time values for these markers.

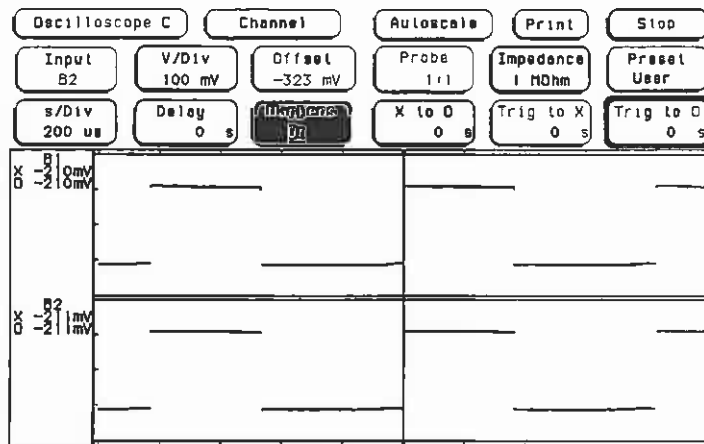

Trig to X Field The X marker is shown on the waveform display as a dashed green line. The time displayed in the **Trig to X** field is measured from the trigger point to the X marker. The trigger point is marked with a dotted red line on the waveform display and is always time 0. A green border around the **Trig to X** field reminds you that the X marker is green.

When the **Trig to X** field is selected, the time value can be changed by turning the knob or by entering a time value from the pop-up keypad. The keypad will appear when you touch the **Trig to X** field when the field is light blue.

Resolution for the **Trig to X** time values is 2% of the sweep speed setting. The default value for the **Trig to X** field is 0 s.

Trig to O Field The O marker is shown on the waveform display as a dashed yellow line. The time displayed in the **Trig to O** field is measured from the trigger point to the O marker. A yellow border around the **Trig to O** field reminds you that the O marker is yellow.

When the **Trig to O** field is selected, the time value can be changed by turning the knob or by entering a time value from the pop-up keypad. The keypad will appear when you touch the **Trig to O** field when the field is light blue.

Resolution for **Trig to O** time values is 2% of the sweep speed setting. The default value for the **Trig to O** field is 0 s.

X to O Field The **X to O** field displays the time (delta time) between the X marker and the O marker. When the **X to O** field is selected, turning the knob will move both the X and the O marker across the display without changing the value in the **X to O** field. However, the values in the **Trig to X** and **Trig to O** fields will change to reflect the movement of the X and O markers.

The value in the **X to O** field can be changed by changing the **Trig to X** or **Trig to O** values, or by changing the **X to O** value from the pop-up keypad. The keypad will appear when you touch the **X to O** field when the field is light blue.

When the time value of **X to O** is changed using the keypad, half the difference of the new value and old value is subtracted from the X marker and half is added to the O marker.

Channel Label Field The channel label field is the dark blue field to the left of the waveform display. When the markers are turned on, the voltage values where the X and O markers intersect each waveform are displayed under each channel label.

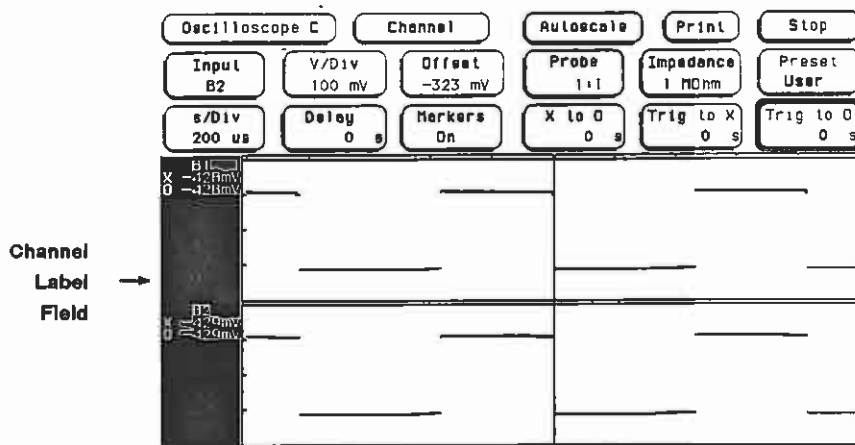

Touch the **Trig to X** field. Now turn the knob and notice how the X marker (green) moves across the display. As you move the marker, the time value in the **Trig to X** field changes. A negative time value indicates the marker is placed before the trigger point, and a positive time value indicates the marker is placed after the trigger point.

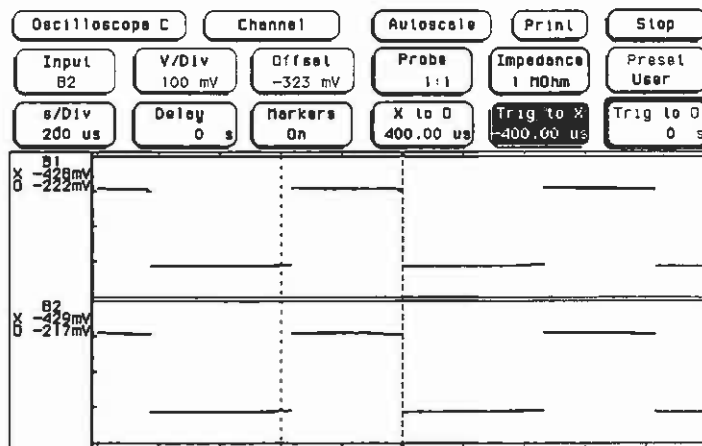

As you turn the knob, the time value in the **X to O** field also changes, showing the time difference between the X and O markers. If the time displayed in the **X to O** field is negative, the O marker is to the left of the X marker.

Now touch the **Trig to O** field. Turn the knob and notice how the O marker (yellow) moves, and how the time values change.

Also notice that as you move the X or O marker from a low portion on the square wave to a high portion, the voltage values in the channel label field also change.

Touch the **X to O** field and turn the knob. The X and O markers now move together and maintain the preset X to O time value.

Automatic Marker Measurements

Touch the **Markers** field. When the pop-up appears touch the **Auto** field. This selects the automatic markers measurements.

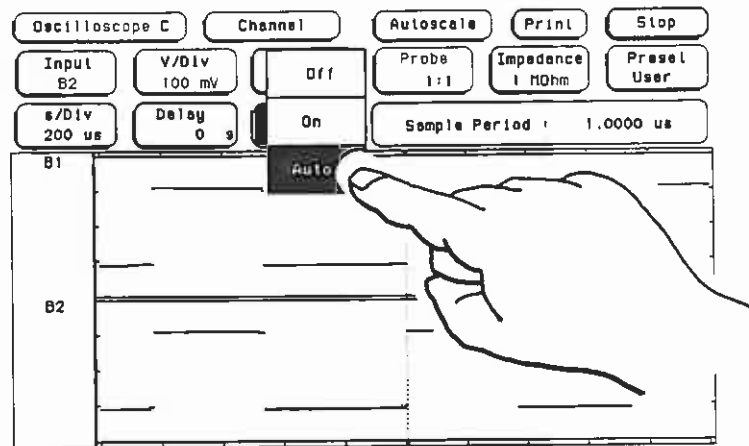

The automatic marker measurements are made by setting the markers to levels that are a percentage of the top-to-base voltage value of a waveform. The top-to-base voltage value of a square wave is typically not the same as the peak-to-peak value. The oscilloscope determines the top and base voltages by finding the flattest portions of the top and bottom of the waveform. The top and base values do not typically include preshoot or overshoot of the waveform. The peak-to-peak voltage is the difference between the minimum and maximum voltage found on the waveform.

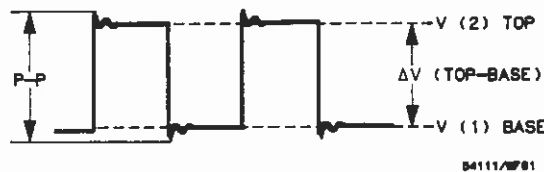

04111/0701

The default auto markers pop-up menu is shown below.

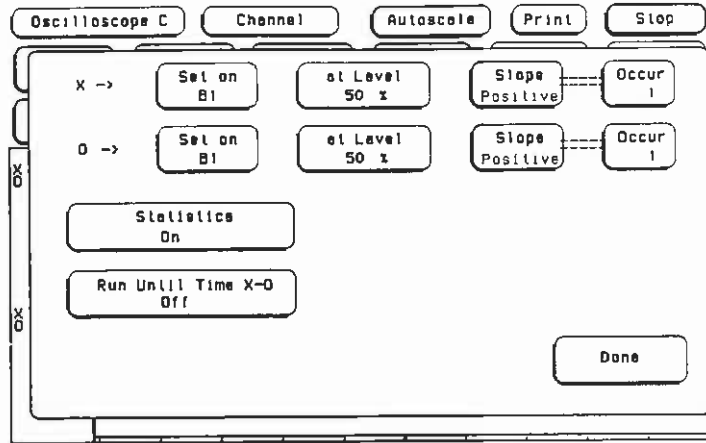

Set on Field The **Set on** field assigns an input waveform (**B1** or **B2** in this example) to the X or O marker, or allows the marker to be set manually. When you touch the **Set on** field, a pop-up appears showing all waveform sources available.

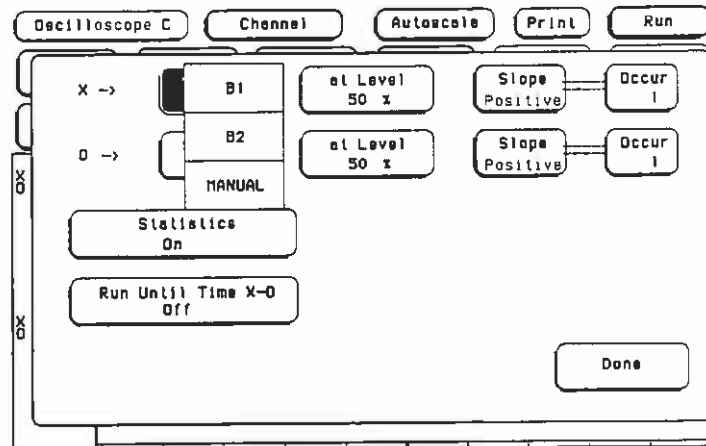

What is displayed on the pop-up is dependent upon how many acquisition boards are installed in the mainframe and in which slots they are installed. If **MANUAL** is selected from the **Set on** pop-up, that marker will be controlled by the knob.

The default selection for the **Set on** field is the lowest letter/number combination. For example, if acquisition boards are installed in mainframe slots B and C, the **Set on** field will default to **B1** for both the X and O markers.

at Level Field The **at Level** field sets the X or O marker to a percentage level (from 10 to 90) of the top-base voltage on the waveform selected by the **Set on** field. When the **at Level** field is selected, the percentage can be changed by turning the knob or by entering a value from the pop-up keypad. The keypad will appear when you touch the **at Level** field when the field is light blue. Any percentage from 10% to 90% in increments of 1% can be entered.

The default value for the **at Level** field is **50%**.

Slope Field The **Slope** field sets the X or O marker on either the positive or negative edge of the selected occurrence of a waveform. When the **Slope** field is touched, the slope will toggle between **Positive** and **Negative**.

The default selection for the **Slope** field is **Positive**.

Occur Field The **Occur** field sets the X or O marker on a specific occurrence of a edge on the waveform. The edge may be the 1st displayed up to the 100th displayed. The count of edge occurrences is made starting with the first edge displayed on screen, either partial or full.

Note

Auto-marker measurements are made with data that is displayed on screen. Make sure the data of interest is fully displayed on screen. For example, if only part of a positive edge is displayed, the 0%-point and 100%-point of the edge is calculated from what is actually displayed on screen. This could cause measurement errors.

When the **Occur** field is selected, the occurrence can be changed by turning the knob or by entering a new value from the pop-up keypad. The keypad will appear when you touch the **Occur** field when the field is light blue. Any number from 1 to 100 in increments of 1 can be entered.

The default value for the **Occur** field is **1**.

Statistics Field The **Statistics** field allows you to make minimum, maximum, and mean time interval measurements from marker X to marker O. When you touch the **Statistics** field, it will toggle between **On** and **Off**. The default selection for the **Statistics** field is **On**.

When **Statistics** is set to **On**, **Min X-O**, **Max X-O**, and **Mean X-O** appear together in a tan field next to the **Markers** field on the main menu.

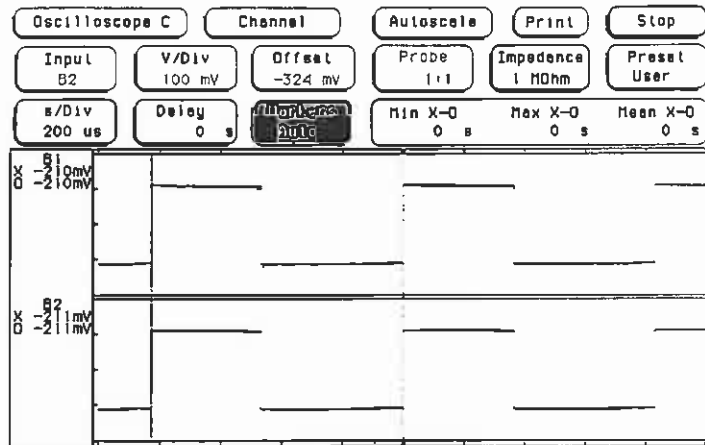

When **On**, the minimum, maximum, and mean (average) X-O marker time interval data is accumulated and displayed until one of the following happens:

1. **Autoscale** is executed.
2. Auto-marker parameters are changed.
3. **Statistics** is set to **Off**.
4. **Repetitive Run** mode is stopped.

When **Statistics** is set to **Off**, the default **X to O**, **Trig to X**, and **Trig to O** fields appear next to the **Markers** field on the main display.

Run Until Time X-O Field

This field lets you set up a stop condition for the time interval between the X marker and O marker. When this condition is met, the oscilloscope will stop making acquisitions and will display **Stop condition satisfied**. These stop conditions will appear when you touch the **Run Until Time X-O** field. The default selection for this field is **Off**.

Note

The Run Until Time X-O feature is only valid if the Run field is set to Repetitive.

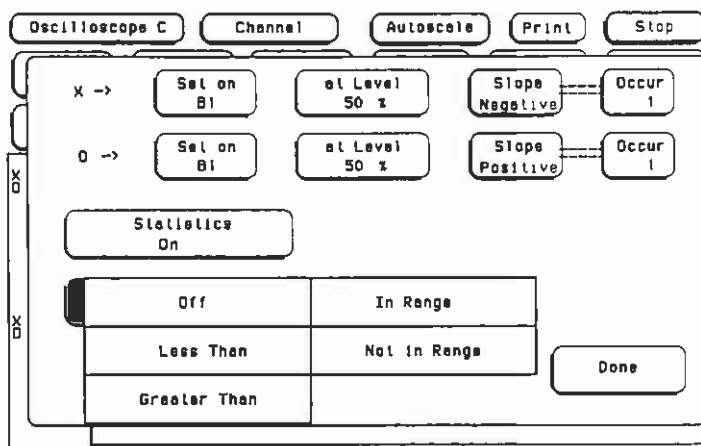

Done field. Touch this field when you are done entering data in the auto-markers pop-up and would like to return to the waveform display.

Less Than field. When this field is selected from the pop-up, a time value field appears next to the Run Until Time X-O Less Than field.

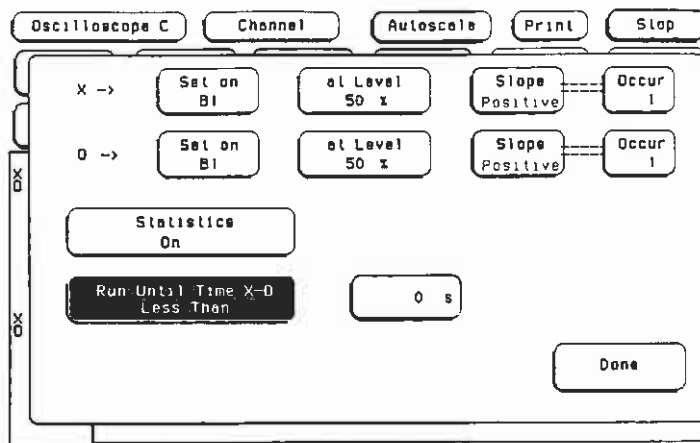

When the time value field is selected, the time can be entered by turning the knob or by entering a value from the pop-up keypad. The keypad will appear when you touch the time value field when the field is light blue. When using the keypad, resolution is 10 ps at times up to ± 99.99 ns and can be set to 5-digit resolution for other times up to ± 100 Megaseconds. Positive times would be used when the X marker is displayed before the O marker, and negative times would be used when the O marker is displayed before the X marker.

When **Less Than** is selected, the oscilloscope will run until the X-O time interval is less than the value entered for the **Less Than** time field. When the condition is met, the oscilloscope will stop acquisitions and display **Stop condition satisfied**.

Greater Than field. When this field is selected from the pop-up, a time value field appears next to the **Run Until Time X-O Greater Than** field. When the time value field is selected, the time can be entered the same as for the **Less Than** field.

When **Greater Than** is selected, the oscilloscope will run until the X-O time interval is greater than the value entered for the **Greater Than** time field. When the condition is met, the oscilloscope will stop acquisitions and display **Stop condition satisfied**.

In Range field. When this field is selected from the pop-up, two time value fields appear next to the Run Until Time X-O In Range field. The time range for the stop condition is entered in these time fields. When either time value field is selected, the time can be entered the same as for the Less Than field.

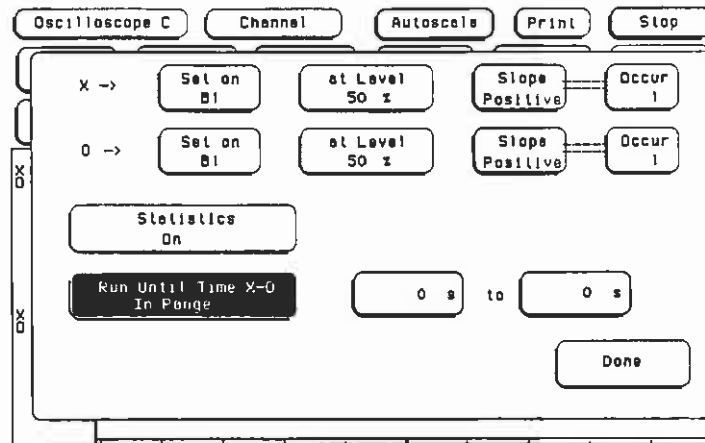

When **In Range** is selected, the oscilloscope will run until the X-O time interval is in the range of the time values entered for the **In Range** time fields. When the condition is met, the oscilloscope will stop acquisitions and display **Stop condition satisfied**.

Not In Range field. When this field is selected from the pop-up, two time value fields appear next to the Run Until Time X-O Not In Range field. The time range for the stop condition is entered in these time fields. When either time value field is selected, the time can be entered the same as for the **Less Than** field.

When **Not In Range** is selected, the oscilloscope will run until the X-O time interval is not in the range of the time values entered for the **Not In Range** time fields. When the condition is met, the oscilloscope will stop acquisitions and display **Stop condition satisfied**.

Auto-Marker Exercise

Set up the oscilloscope as shown in "Marker Measurements" on page 9-3. Let's set up the auto marker pop-up to make an X-O marker measurement on the **B1** and **B2** input waveforms. We want to measure the time between the falling edge of the 2nd displayed pulse on **B1** to the rising edge of the 5th displayed pulse on **B2**. We'll perform the measurement from the 10% point on **B1** to the 90% point on **B2**.

1. Touch the **Markers** field. When the pop-up appears, touch the **Auto** field. The auto-markers pop-up menu is now displayed.
2. Set the X marker (green) to the 10% point of the 2nd negative edge of **B2**.
 - a. Touch the **Set on** field and select **B2** (2nd pulse) from the pop-up.
 - b. Touch the **at Level** field and turn the knob until the field displays **10%**.
 - c. Touch the **Slope** field until the field displays **Negative**.
 - d. Touch the **Occur** field and turn the knob until the field displays **2**.
3. Set the O marker (yellow) to the 90% point of the 5th positive edge of **B1**.
4. Leave **Statistics On** and **Run Until Time X-O Off**.
5. The auto-marker pop-up should now look like the screen below.

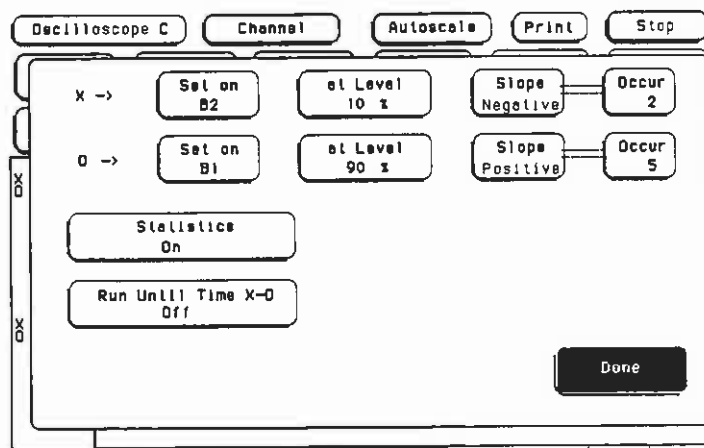

Touch the **Done** field to return to the waveform display. There aren't enough cycles of the waveform being displayed at this time to display the **O** marker on the 5th **B2** pulse, so the oscilloscope displays **No level found for the O-marker**. Touch the **s/Div** field and set the sweep speed to 500 $\mu\text{s}/\text{division}$. The **X** marker is on the falling edge of the 2nd displayed pulse and the **O** marker is on the rising edge of the 5th displayed pulse. The statistical minimum, maximum, and mean time interval measurements between the **X** and the **O** markers are displayed in the tan field next to the **Markers** field. The voltage measurements of where the markers intersect the waveforms are displayed in the channel label field under the **B1** and **B2** labels.

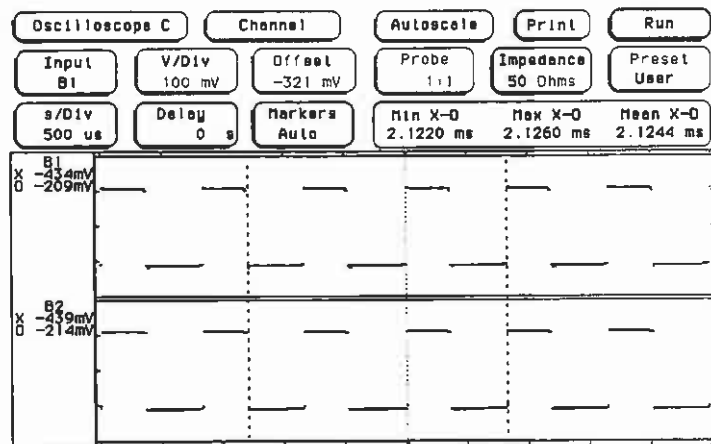

Touch the **Delay** field, and turn the knob. Notice that as the waveform is moved across the display, the **X** and **O** markers also move to the edges specified in the auto-markers pop-up menu.

Set the **Delay** time back to **0 s**.

Let's go back to the auto-marker pop-up menu and set up an X-O measurement using the **Run Until Time X-O** feature.

1. Touch the **s/Div** field and turn the knob to change the sweep speed to 5 ns/div.
2. Touch the **Markers** field and select **Auto** from the pop-up.
3. Change the X marker fields to:
Set on B1
at Level 50%
Slope Positive
Occur 1
4. Change the O marker field to:
Set on B2
at Level 50%
Slope Positive
Occur 1
5. Touch **Run Until Time X-O** field and select **Less Than** from the pop-up.
6. Touch the time field next to the **Less Than** field. Turn the knob to set the time to **5.00 ns**.
7. The auto-marker pop-up should now look like the screen below.

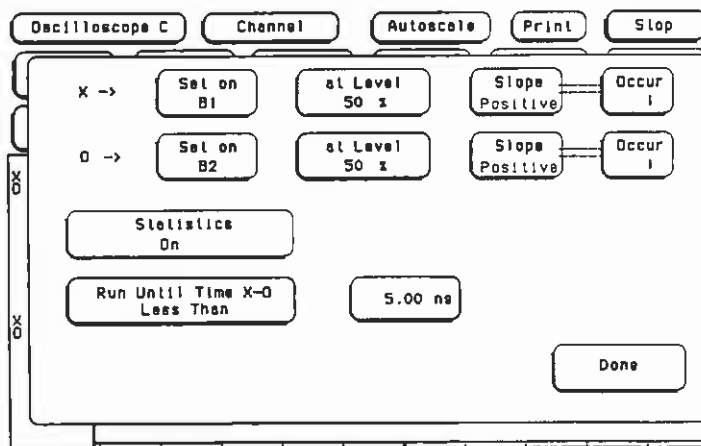

Touch the **Done** field to return to the waveform display. The display now looks like that shown below. The time interval from X-O in this example is -6.7171 ns. The time is negative because the O marker is displayed before the X marker. The oscilloscope was instructed to run until the time interval was less than 5 ns. When the stop condition was satisfied, the oscilloscope stops acquisition and displays the advisory **Stop condition satisfied**.

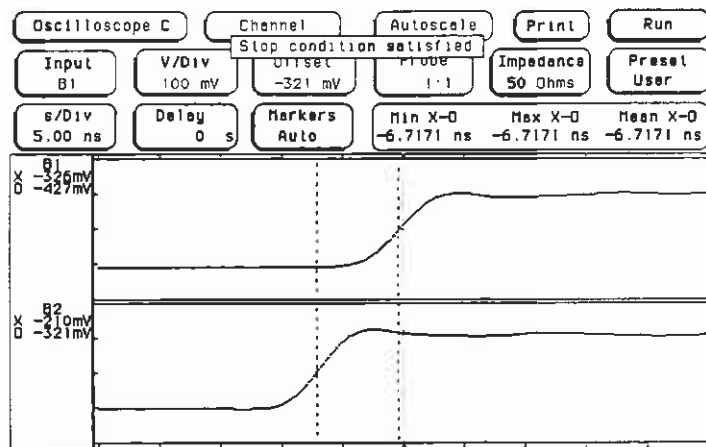

Touch the **Markers** field and select the **Auto** field from the pop-up. Touch the **Set on** field for the X marker. Notice the pop-up field can be set to manual. This allows you to have one marker set automatically and one marker set to be controlled manually with the knob.

Touch the **MANUAL** field in the pop-up. Now touch **Done** in the auto-markers pop-up to return to the waveform display. Touch the **Markers** field again and select **On** from the pop-up. The X marker is now set to the manual mode and the O marker is set to the automatic mode.

10

Display Menu

Introduction

The **Display** menu controls how the oscilloscope acquires and displays waveforms. The waveforms may be displayed in normal, averaged, or accumulated mode. This menu also controls the connect-the-dots display feature. The default **Display** menu is shown below.

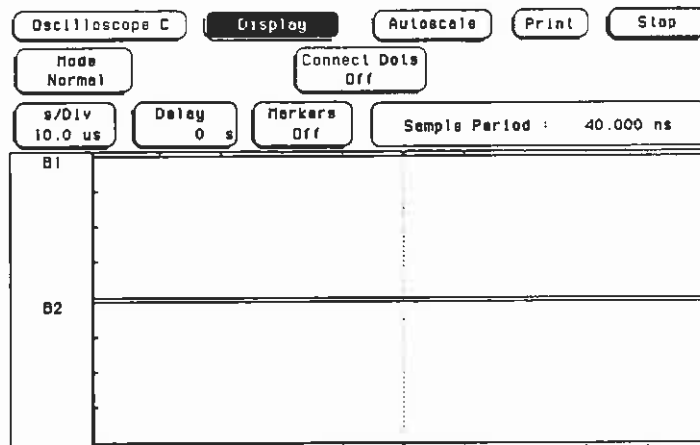

Display Menu Map

The menu map for the **Display** menu is shown below.

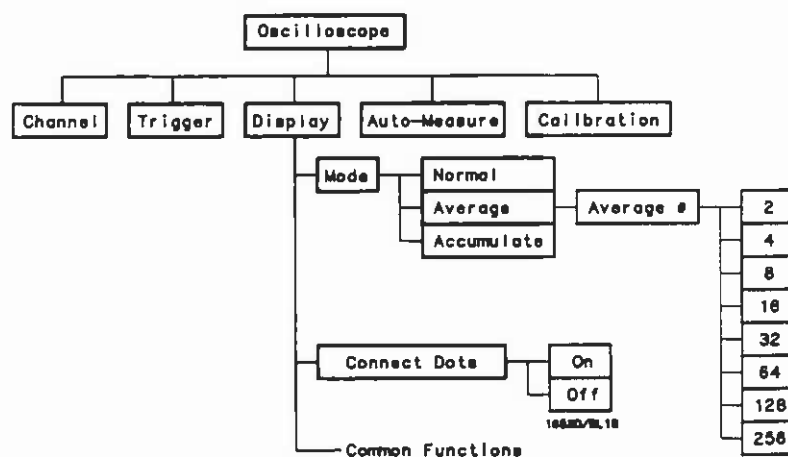

Mode Field

The **Mode** field determines how waveform information is acquired and displayed.

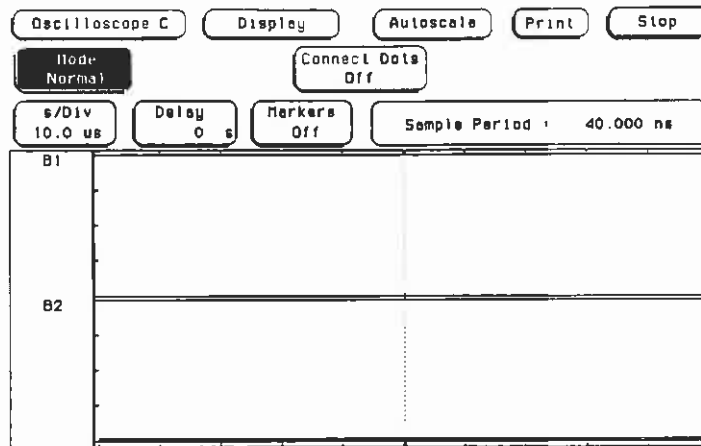

When you touch the **Mode** field, a pop-up field will appear as shown below. **Normal**, **Average**, or **Accumulate** mode can be selected from the pop-up. The default selection for the **Mode** field is **Normal**.

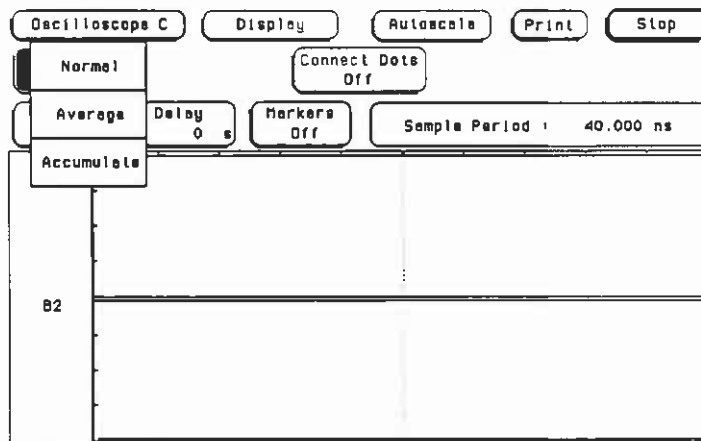

Normal Mode In Normal mode, the oscilloscope acquires waveform data and then displays the waveform. When the oscilloscope makes a new acquisition, the previously acquired waveform is erased from the display and replaced by the newly acquired waveform.

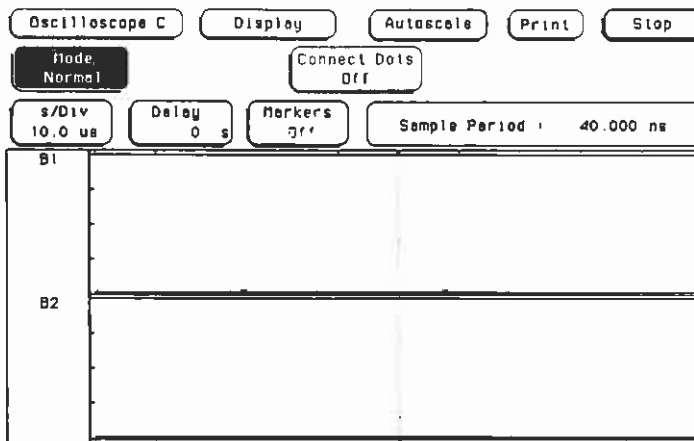

Average Mode In Average mode, the oscilloscope averages the data points on the waveforms with previously acquired data. Averaging helps eliminate random noise from your displayed waveforms.

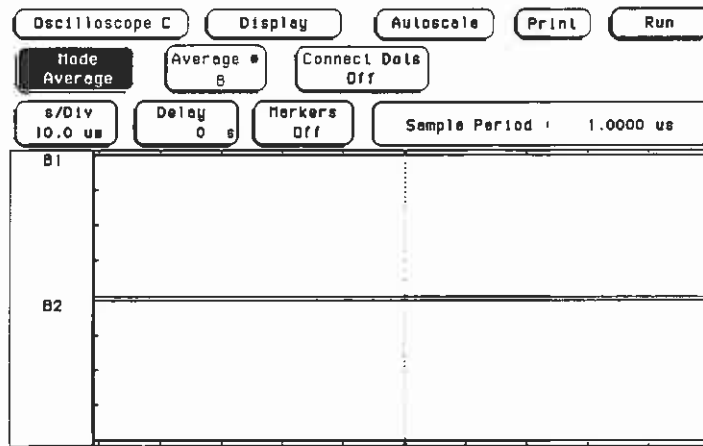

When the Average mode is selected, a new field appears next to the Mode field which allows you to select the number of averages to make. When the Average # field is selected, the number of averages can be changed by turning the knob. The number of averages can be set to 2, 4, 8, 16, 32, 64, 128, or 256.

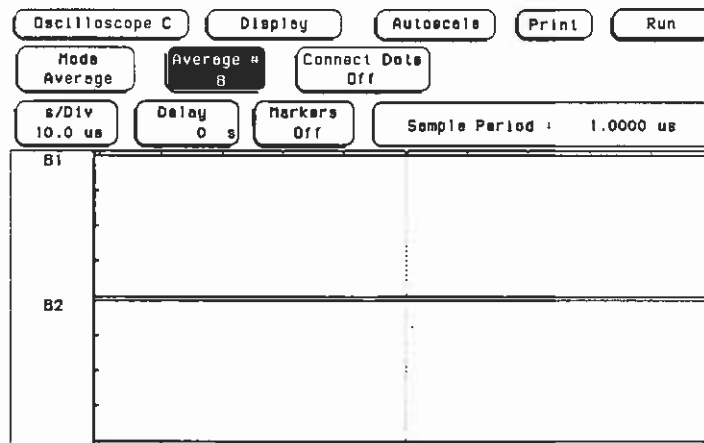

As an example, assume the **Average #** field is set to **16**. If the **Run** mode is set to **Repetitive**, the oscilloscope will immediately start acquiring waveform data and average them together. When the initial 16 waveforms have been acquired, the oscilloscope will momentarily display the advisory **Number of averages have been met**. Once the initial 16 waveforms have been acquired, the oscilloscope will only average the last 16 waveforms acquired; all other data will be discarded.

If the **Run** mode is set to **Single**, an acquisition is not made until the **Run** field has been touched. If **Average #** is set to **16**, as in the previous example, **Number of averages have been met** would not be displayed until **Run** has been touched 16 times.

Average # can also be entered with the pop-up keypad. The keypad will appear when you touch the **Average #** field when the field is light blue. Any power of 2 from 2 to 256 can be entered.

The default value for the **Average #** field is **8**.

Accumulate Mode

In **Accumulate** mode, the oscilloscope accumulates all waveform acquisitions on screen without erasing the previously acquired waveforms. This is similar to infinite persistence on an analog storage oscilloscope. These acquisitions will stay on the display until **Mode** is changed, or until the waveform is adjusted by a control that causes the display to change, such as **s/Div** or **V/Div**.

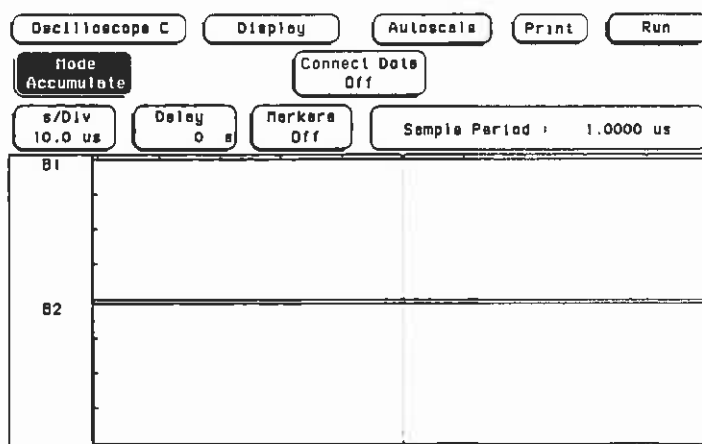

Connect Dots Field

What you see on the display below looks like two parallel dashed lines, because each sample is displayed as a single dot.

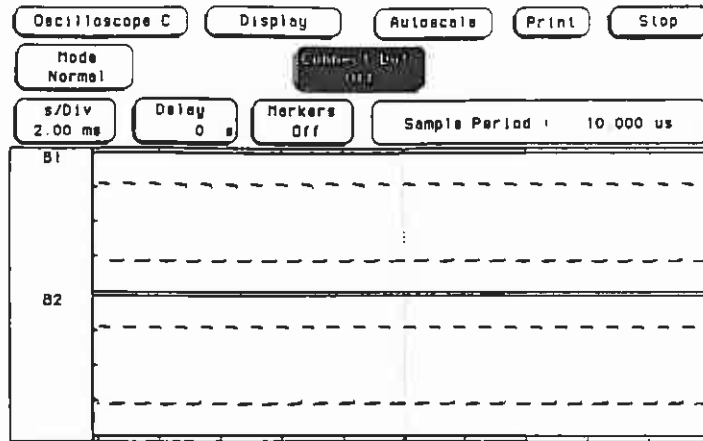

To give you a better idea of what the waveform looks like, the oscilloscope has a feature that connects the sample dots together. When **Connect Dots** is **On**, each displayed dot will be connected to the adjacent dot by a straight line. The same waveform with **Connect Dots** set to **On**, is now well defined and easier to see.

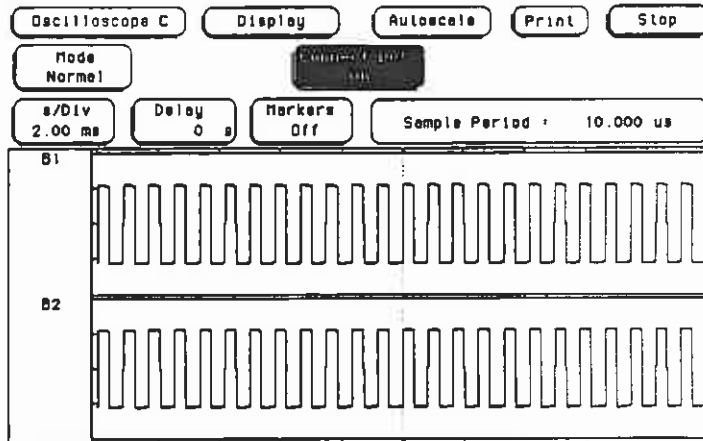

The default setting for the **Connect Dots** field is **Off**.

11

Auto-Measure Menu

Introduction

Automatic parametric measurements are functions built into the digitizing oscilloscope that make parametric measurements on a displayed waveform. There are nine automatic measurements available in the automatic measurement menu:

- Period
- Risetime
- Falltime
- Frequency
- +Width
- Width
- Vp_p
- Preshoot
- Overshoot

Auto-Measure Menu Map

The menu map for the Auto-Measure menu is shown below.

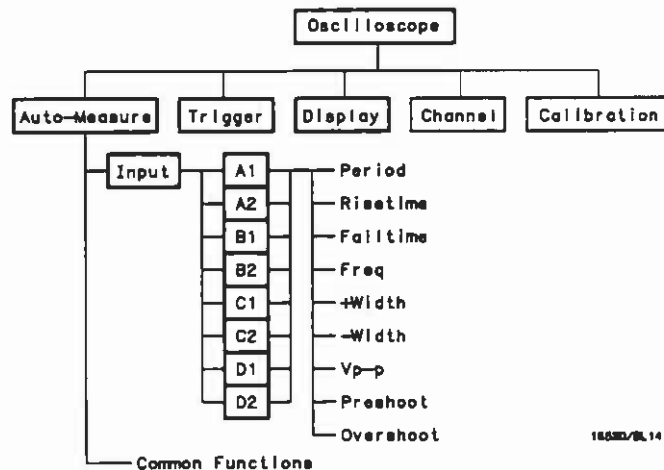

Top and Base Voltages

All measurements except V_{p-p} are calculated using the V_{top} (100% voltage) and V_{base} (0% voltage) levels of the displayed waveform. The V_{top} and V_{base} levels are determined from an occurrence density histogram of the data points displayed on screen.

The digitizing oscilloscope displays 6-bit vertical voltage resolution. This means the vertical display is divided up into 2^6 voltage levels. Each of these 64 levels is called a quantization level. Each waveform has 500 data points displayed horizontally on screen. Each of these 500 points has one quantization level assigned to it. The histogram is calculated by adding the number of occurrences of each quantization level of the 500 displayed points on the displayed waveform.

The quantization level with the greatest number of occurrences in the top half of the waveform corresponds to the V_{top} level. The quantization level with the greatest number of occurrences in the bottom half of the waveform corresponds to the V_{base} level.

If V_{top} and V_{base} do not contain at least 5% of the 500 data points displayed on screen, V_{top} defaults to the maximum voltage ($V_{maximum}$) and V_{base} defaults to the minimum voltage ($V_{minimum}$) found on the display. An example of this case would be measurements made on sine or triangle waves.

From this information the instrument can determine the 10, 50, and 90% points, which are used in most automatic measurements. The V_{top} or V_{base} of the waveform is not necessarily the maximum or minimum voltage present on the waveform. If a pulse has a slight amount of overshoot, it would be wrong to select the highest peak of the waveform as the top since the waveform normally rests below the perturbation.

Automatic Measurement Setup

To demonstrate how to make automatic measurements, set up the oscilloscope as described below. This setup will be used throughout the remainder of this chapter.

Connecting the Equipment

Connect one BNC tee adapter and two 1-metre BNC cables to the oscilloscope as shown below.

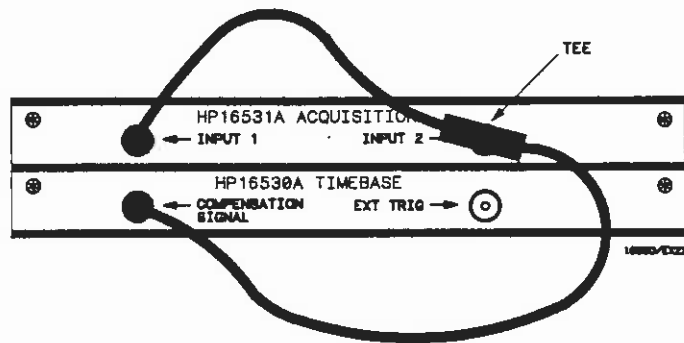

Setting Up the Oscilloscope

1. Turn the power on to the instrument.
2. Touch the **System** module field and select **Oscilloscope** from the pop-up.
3. From the default oscilloscope **Channel** menu, make the following changes:
 - Input 1 **Probe** field to 1:1
 - Input 1 **Impedance** field to 50 Ohms
 - Input 2 **Probe** field to 1:1
 - Input 2 **Impedance** field remains at 1 MOhm
4. Touch the **Autoscale** field to autoscale the signal.
5. Touch the **Run** field and drag your finger to the **Repetitive** field in the pop-up.

6. The display should now look like this:

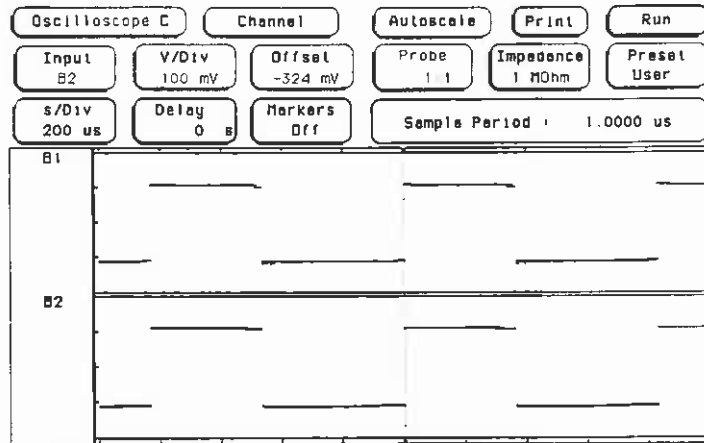

Auto-Measure Menu The Auto-Measure menu is accessed by touching the menu field (top row, second from the left), then selecting Auto-Measure from the pop-up. The default Auto-Measure menu is shown below.

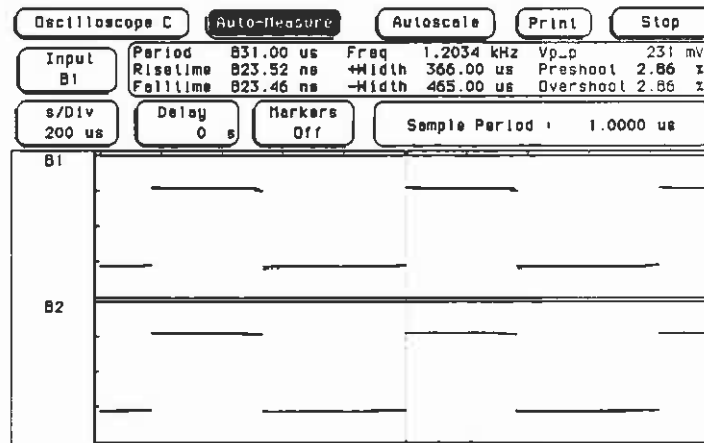

Input Field The **Input** field selects the source of the waveform to be measured. Make sure the proper source is selected for the input you are using. When you touch this field, a pop-up appears showing the input sources.

What is displayed in the **Input** pop-up is dependent upon how many acquisition boards are installed in the mainframe and in which slots they are installed. In this example the inputs are **B1** and **B2**.

The default selection for the **Input** field is the lowest letter/number input channel. For example, if acquisition cards were installed in mainframe slots B, C, and D, the **Input** field would default to **B1**.

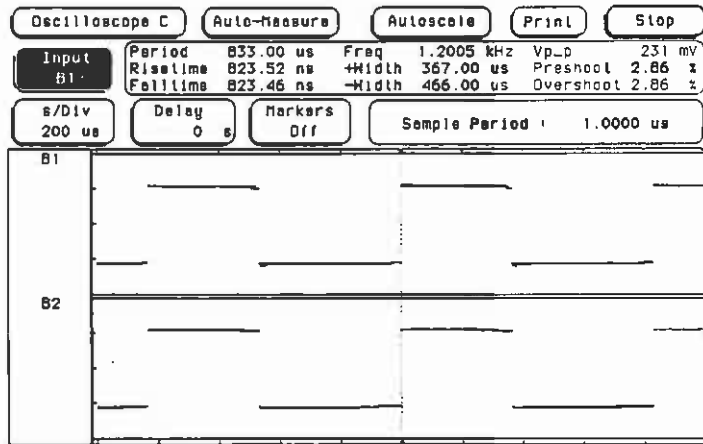

Measurement Field The tan field in the middle row of the menu displays the nine automatic measurements that can be made. Automatic measurements are made only with data that is currently being displayed in the waveform display. Keep the following in mind when making measurements.

- At least one full cycle of the waveform with at least two like edges must be displayed for **Period** and **Freq** measurements.
- A complete positive pulse must be displayed to make a **+Width** measurement, and a complete negative pulse must be displayed to make a **-Width** measurement.
- **Risetime**, **Falltime**, **Preshoot**, and **Overshoot** measurements will be more accurate if you expand the edge of the waveform by selecting a faster sweep speed.

Rise Time Measurement

Touch the **s/Div** field and turn the knob to change the sweep speed to 5 ns/div. Expanding the edge on the waveform will give more accurate results because more data points on the rising edge will be displayed.

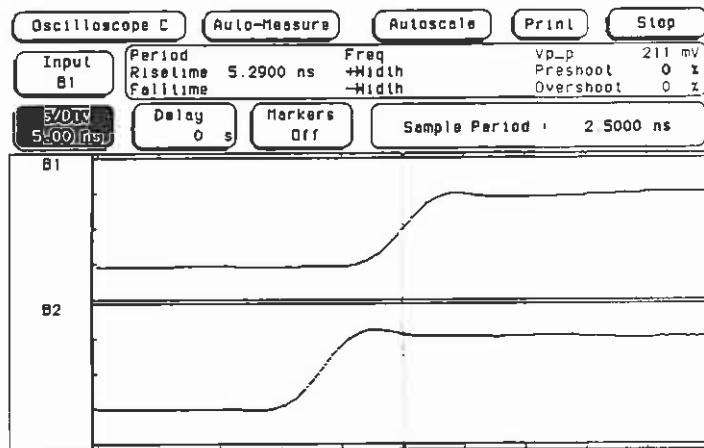

Risetime is measured on the positive-going edge of the waveform and is the time it takes the waveform to transition between the 10% voltage point and the 90% voltage point. The risetime value is displayed in the **Risetime** field.

Notice that **Period**, **Falltime**, **Freq**, **+Width**, and **-Width** fields are blank. Because only the rising edge of the waveform is displayed, there is insufficient data at this time to make these measurements.

Fall Time Measurement

Fall time is measured on the negative-going edge of the waveform and is the time it takes the waveform to transition between the 90% voltage point and 10% voltage point. You are currently displaying the positive-going edge of the waveform, so you need to change it to the negative-going edge.

1. Touch the **Auto-Measure** field.
2. When the pop-up appears, touch the **Trigger** field to display the **Trigger** menu.
3. Touch the **Slope** field to change the displayed slope from **Positive** to **Negative**.

Notice the negative-going edge of the waveform is now displayed.

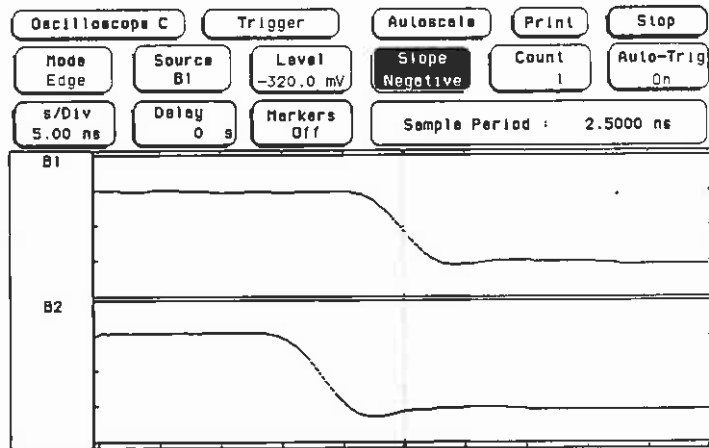

Now touch the **Trigger** field and select **Auto-Measure** from the pop-up to return to the **Auto-Measure** menu.

The fall time value is displayed in the **Falltime** field.

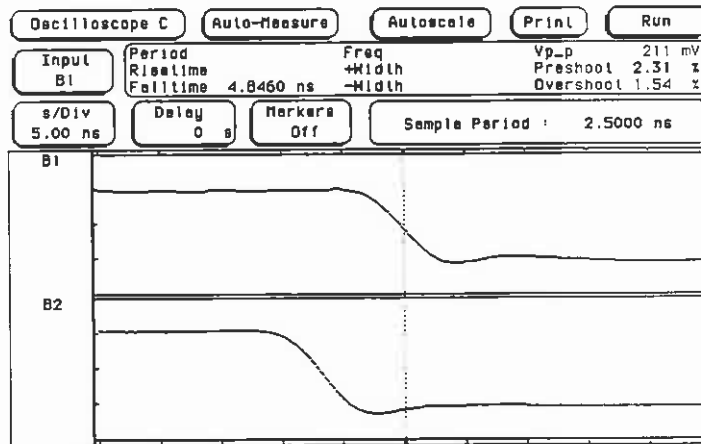

Now measure the **Falltime** on Input **B2**.

1. Touch the **Input** field.
2. Select **B2** from the pop-up.

Falltime is now being measured on **B2**.

Vp_p Measurement

The peak-to-peak voltage measurement uses the maximum voltage and the minimum voltage found in the data displayed on screen for the selected source.

$$Vp_p = V_{\text{maximum}} - V_{\text{minimum}}$$

The Vp_p measurement is displayed in the upper left corner of the auto-measurement field.

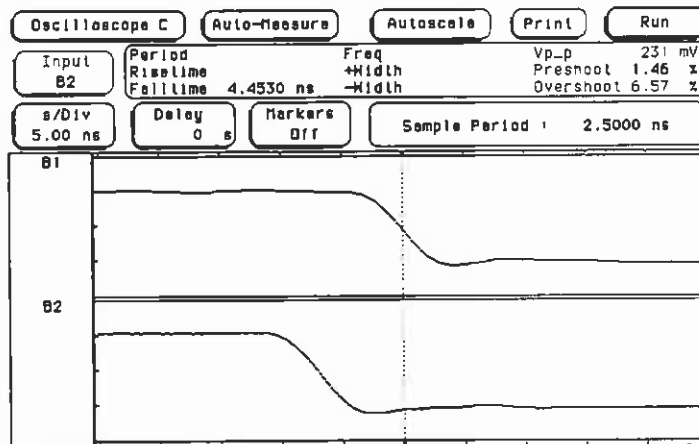

Period and Frequency Measurements

Period and Freq (frequency) measurements are made using the first two like edges of an input displayed on screen. At least one full cycle of the waveform must be displayed to make the measurements. If a full cycle is not present, the Period and Freq measurements in the auto-measure field will be blank. Period and Freq are measured using the time (t) at the 50% level of the edges.

If the first edge on the display is rising then

$$\text{Period} = t_{\text{rising edge 2}} - t_{\text{rising edge 1}}$$

$$\text{Freq} = 1 / (t_{\text{rising edge 2}} - t_{\text{rising edge 1}})$$

If the first edge on the display is falling then

$$\text{Period} = t_{\text{falling edge 2}} - t_{\text{falling edge 1}}$$

$$\text{Freq} = 1 / (t_{\text{falling edge 2}} - t_{\text{falling edge 1}})$$

Rescale the waveform to display at least one full cycle of the waveform, then make a Period and Freq measurement on B1.

1. Touch **Autoscale**.
2. Select **Continue** from the pop-up.
3. Change s/Div field to 100 us to display only one full cycle of the waveform.

Period and Freq measurements are displayed in the top row of the auto-measurement field.

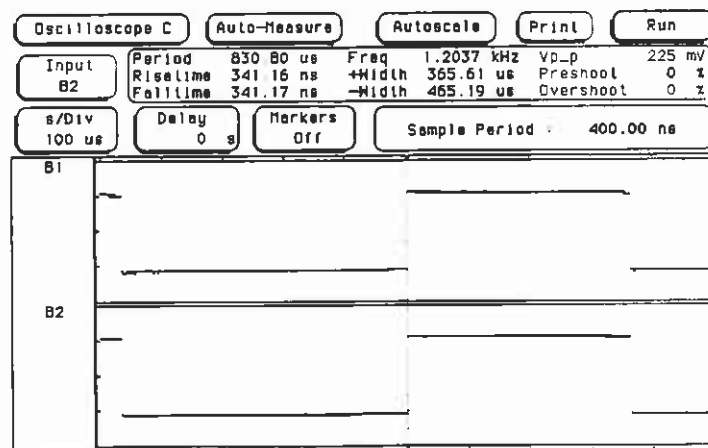

+Width and -Width Measurements

+Width (positive pulse width) and -Width (negative pulse width) measurements are made using the time (t) at the 50% level of the waveform edges. At least one positive-going edge followed by a negative-going edge of the waveform must be present to make a +Width measurement and at least one negative-going edge followed by a positive-going edge must be present to make a -Width measurement. If these conditions are not present, the +Width and/or -Width measurements in the auto-measure field will be blank.

If the first edge on the display is rising then

$$+Width = t_{falling\ edge\ 1} - t_{rising\ edge\ 1}$$

$$-Width = t_{rising\ edge\ 2} - t_{falling\ edge\ 1}$$

If the first edge on the display is falling then

$$+Width = t_{falling\ edge\ 2} - t_{falling\ edge\ 1}$$

$$-Width = t_{rising\ edge\ 1} - t_{falling\ edge\ 1}$$

Rescale the waveform to display at least one full cycle of the waveform, then make a +Width and -Width measurement on B1.

1. Touch **Autoscale**.
2. Select **Continue** from the pop-up.
3. Change **s/Div** field to **100 us** to display only one full cycle of the waveform.

+Width and -Width measurements are displayed in the top row of the auto-measurement field.

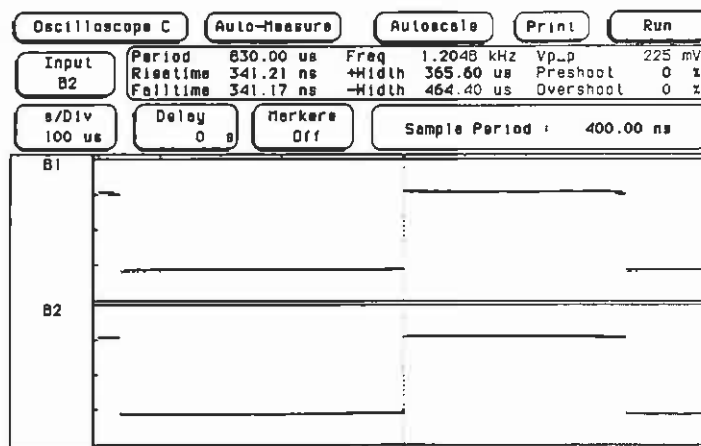

Preshoot and Overshoot Measurements

Preshoot and **Overshoot** measure the perturbation on a waveform above or below the top and base voltages (see "Top and Base Voltages" section earlier in this chapter). These measurements use all data displayed on screen, therefore it is very important that only the data of interest be displayed. If you want to measure preshoot and overshoot on one edge of a waveform, then only display that edge. If you want to measure the maximum preshoot and overshoot on a waveform, then display several cycles of the waveform.

Preshoot is a perturbation before a rising or a falling edge and is measured as a percentage of the top-base voltage.

Overshoot is a perturbation after a rising or a falling edge and is measured as a percentage of the top-base voltage

If the measured edge is rising then

$$\text{Preshoot} = \left[\frac{V_{\text{base}} - V_{\text{minimum}}}{V_{\text{top-base}}} \right] \times 100$$

$$\text{Overshoot} = \left[\frac{V_{\text{maximum}} - V_{\text{top}}}{V_{\text{top-base}}} \right] \times 100$$

If the measured edge is falling then

$$\text{Preshoot} = \left[\frac{V_{\text{maximum}} - V_{\text{top}}}{V_{\text{top-base}}} \right] \times 100$$

$$\text{Overshoot} = \left[\frac{V_{\text{base}} - V_{\text{minimum}}}{V_{\text{top-base}}} \right] \times 100$$

Rescale the waveform, display a rising edge, then make a **Preshoot** and **Overshoot** measurement on **B1**.

1. Touch **Autoscale**.
2. Select **Continue** from the pop-up.
3. Change **s/Div** field to **5 ns** to display a rising edge.

Preshoot and Overshoot measurements are displayed in the right side of the auto-measurement field. Preshoot is measured at the bottom of the rising edge and Overshoot is measured at the top of the rising edge.

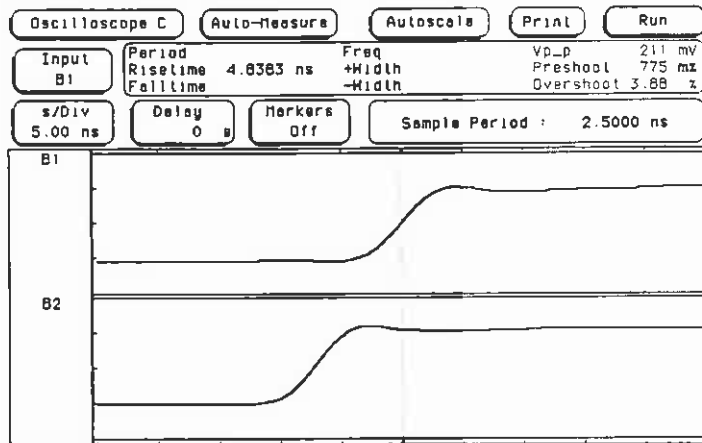

Go to the Trigger menu, change the Slope field to Negative, then return to the Auto-Measure menu. The negative-going edge of the waveform is now displayed.

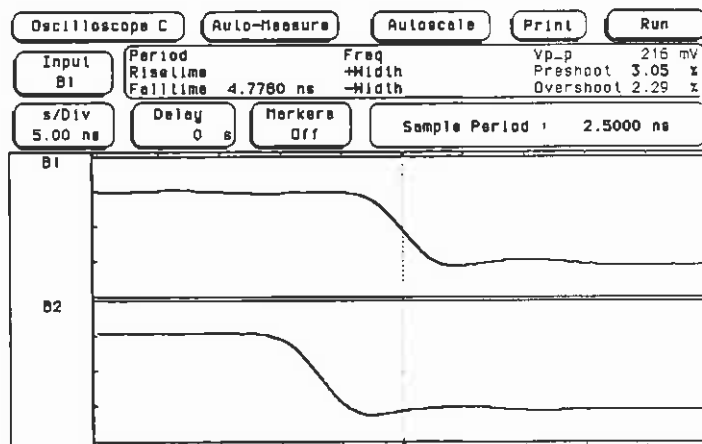

Preshoot now is measured at the top of the falling edge and Overshoot is measured at the bottom of the falling edge.

12

Waveform Selection

Introduction

This chapter will show you how to insert, replace, and delete input channels on the waveform display and how to perform waveform math and overlay functions. Any of these operations can be performed from any of the oscilloscope menus.

The dark-blue channel label field to the left of the waveform display shows the input channels that are being displayed. In this example, **B1** and **B2** signify INPUT 1 and INPUT 2 from the acquisition card in mainframe slot B.

When you touch the channel label field, the **WAVEFORM SELECTION** pop-up menu will appear as shown below. This menu allows you to insert, delete, or replace an input channel and choose channel modes.

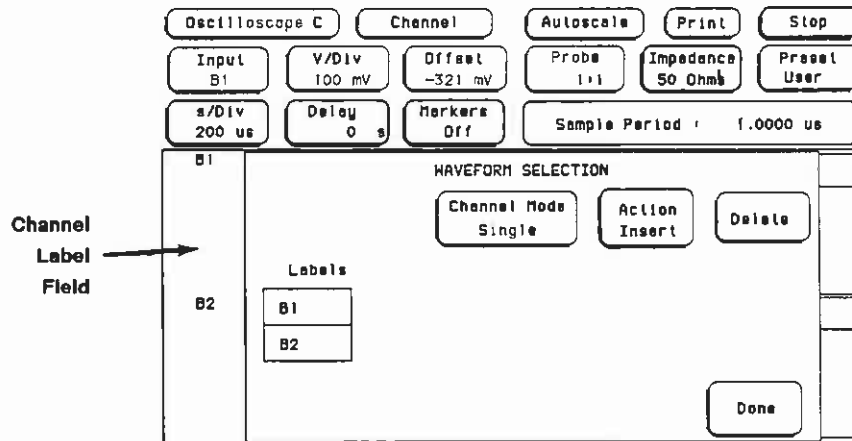

Waveform Selection Menu Map

The menu map for the **WAVEFORM SELECTION** pop-up is shown below.

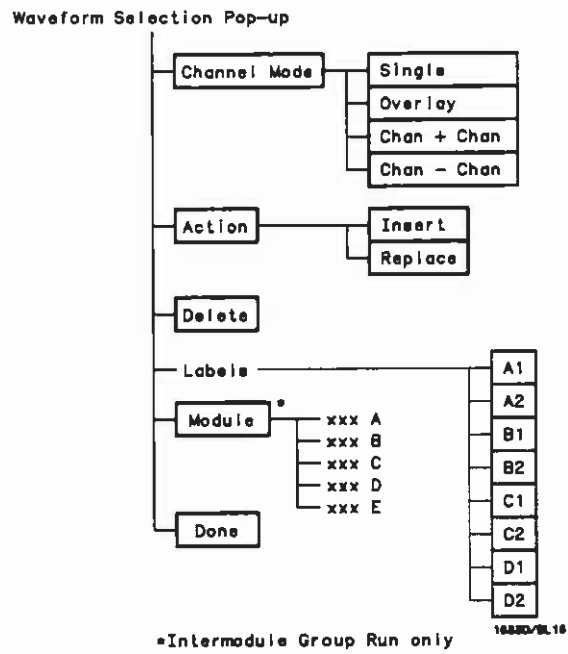

Waveform Selection Setup

Set up the oscilloscope as described below. This setup will be used throughout the remainder of this chapter.

Connecting the Equipment

Connect one BNC tee adapter and two 1-metre BNC cables to the oscilloscope as shown below.

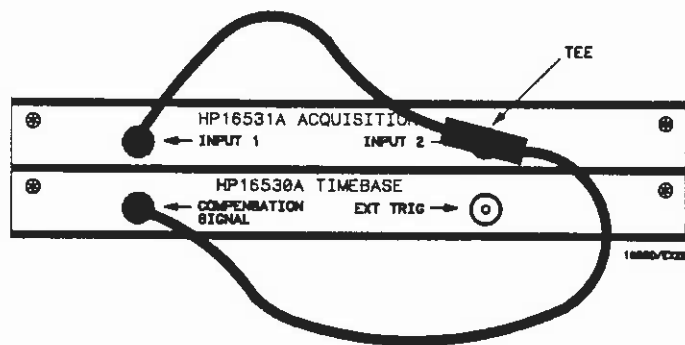

Setting Up the Oscilloscope

1. Turn the power on to the Instrument.
2. Touch the **System** module field and select **Oscilloscope** from the pop-up.
3. From the default oscilloscope **Channel** menu, make the following changes:
 - Input 1 **Probe** field to 1:1
 - Input 1 **Impedance** field to 50 Ohms
 - Input 2 **Probe** field to 1:1
 - Input 2 **Impedance** field remains at 1 MOhm
4. Touch the **Autoscale** field to autoscale the signal.
5. Touch the **Run** field and drag your finger to the **Repetitive** field in the pop-up.

6. The display should now look like this:

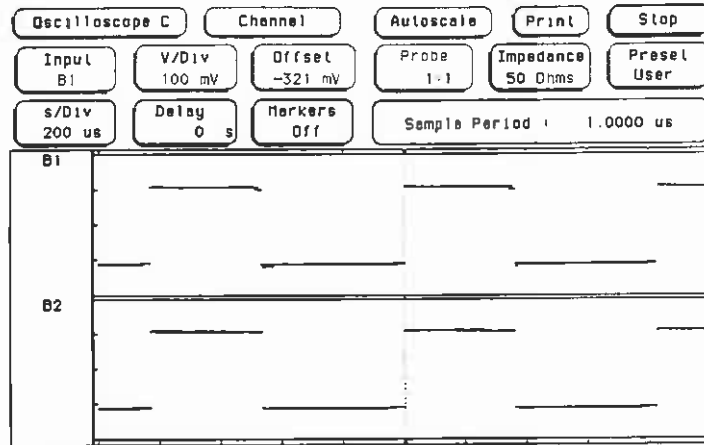

Replacing a Channel

Touch the **Action** field in the pop-up; each time you touch this field, the action will alternate between **Insert** and **Replace**. This field allows you to insert a channel or replace a channel being displayed.

Now turn the knob both directions and notice that **B1** or **B2** in the channel label field is highlighted in white. The area highlighted in white tells you where the channel will be inserted or replaced.

1. Touch the **Action** field until **Replace** is displayed.
2. Turn the knob so that **B1** is highlighted in white.
3. Touch the label **B2** as shown below.

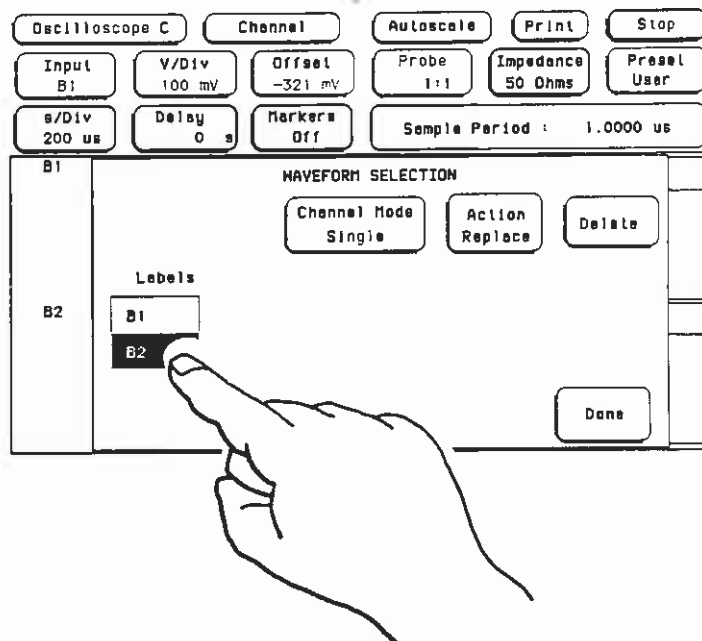

Input channel **B2** has now replaced **B1**. Remember, when you replace an input channel, the new channel replaces the input highlighted in white.

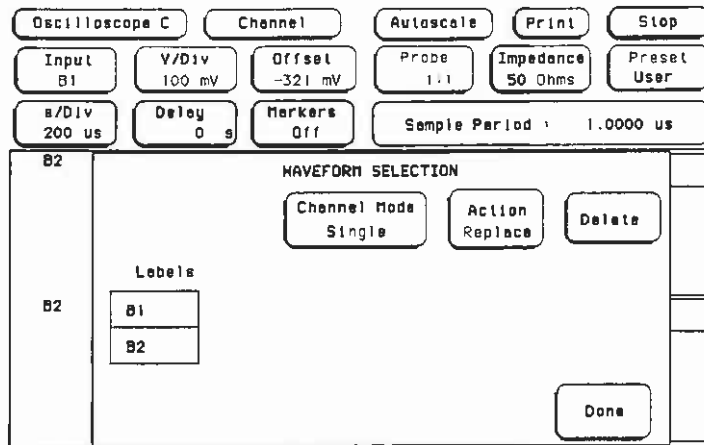

Turn the knob so that the top **B2** is highlighted in white. Touch the label **B1** to replace **B2** with **B1**.

Inserting a Channel

Inserting an input channel works similar to replacing a channel.

1. Touch the Action field until Insert is displayed.
2. Turn the knob so that B1 is highlighted in white.
3. Touch the label B2 as shown below.

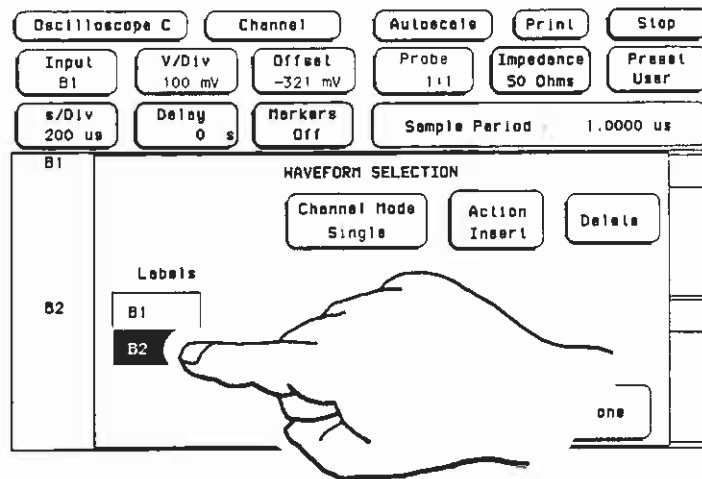

Input channel B2 has now been inserted between the original B1 and B2. Remember, when you insert a channel, the inserted channel will always appear below the Input highlighted in white.

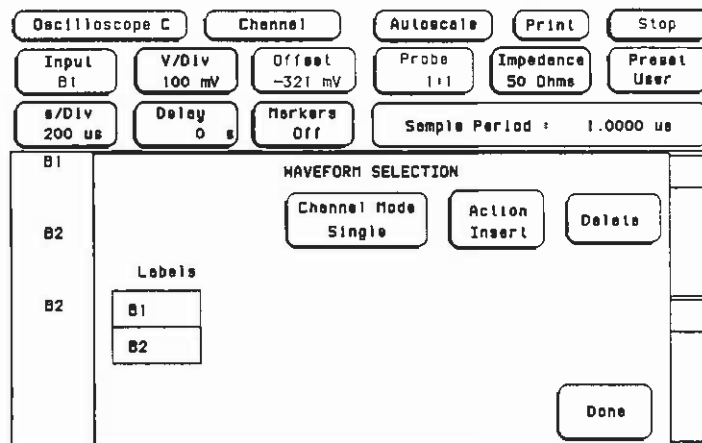

Alternately touch the labels **B1** and **B2** until eight labels have been added to the channel label field. Now press the **Done** field in the pop-up to return to the waveform display.

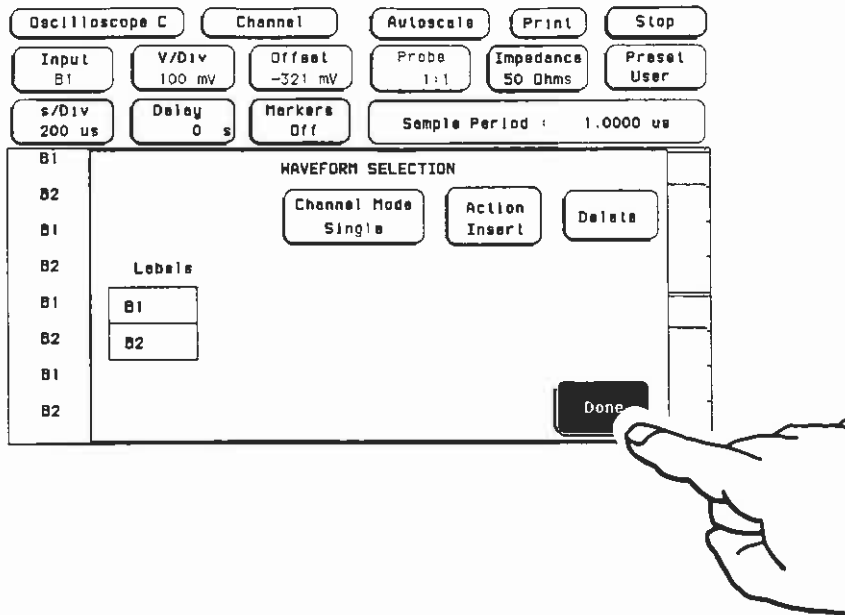

The waveform display should now look like this. Eight waveforms are displayed; INPUT 1 is yellow and INPUT 2 is green.

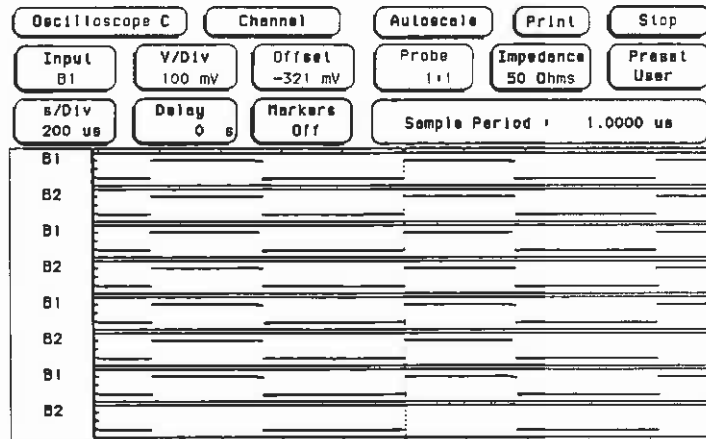

Deleting a Channel

Touch the channel label field at the left of the waveform display to return the the **WAVEFORM SELECTION** pop-up. Use the knob to select the waveform label to delete. Touch the **Delete** field in the pop-up. The input channel highlighted in white will be deleted when the **Delete** field is touched.

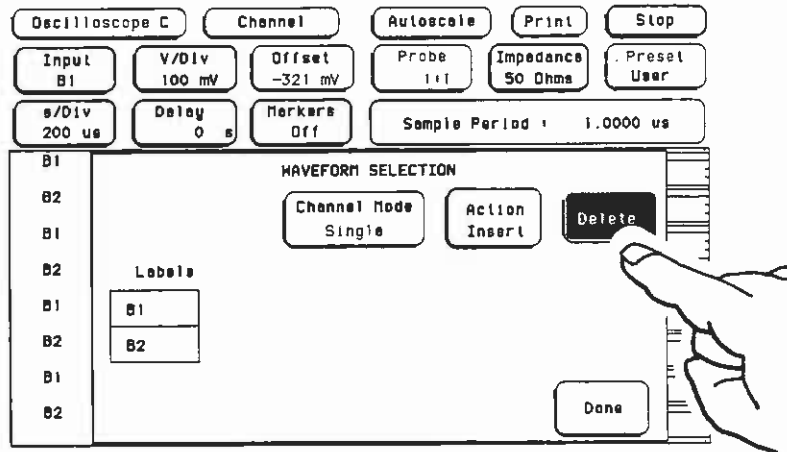

Continue touching the **Delete** field until all but two input channels are deleted.

Waveform Math and Overlay

While you are still in the **WAVEFORM SELECTION** pop-up, touch the **Channel Mode** field. A pop up will appear showing the channel mode selections available. The **Channel Mode** field selects how the waveform will be displayed.

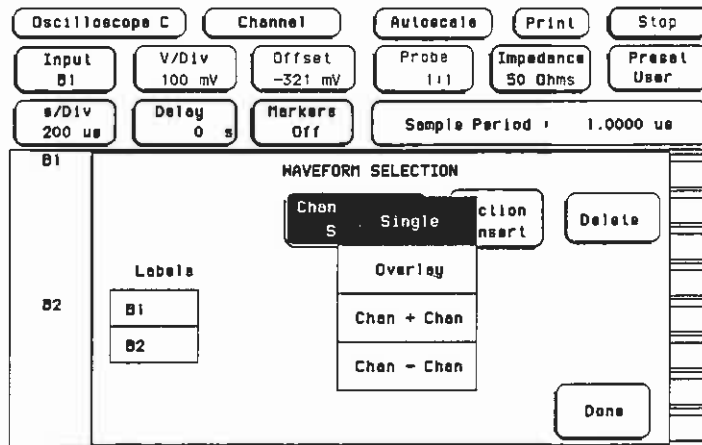

Single What we have been displaying so far in this chapter are examples of **Single** channel mode. This mode displays a single input channel in each waveform display.

Overlay Suppose you wanted to take the signal from Input 1 and compare it to the signal from Input 2. The easiest way to do this would be to put both waveforms on the same waveform display, or overlay the waveforms. Touch the **Overlay** field.

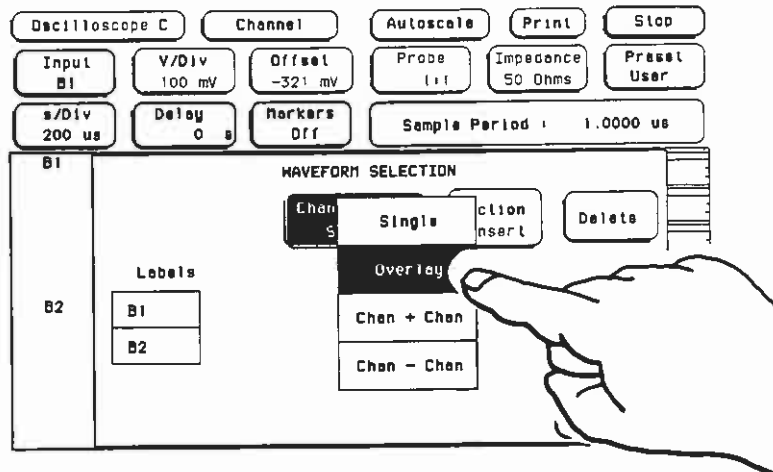

Let's overlay Input 1 with Input 2 in the top waveform display.

1. Turn the knob so that **B1** is highlighted in white.
2. Touch the **Action** field until **Replace** is displayed.
3. Touch the label **B1** in the pop-up, then touch **B2** in the pop-up.
B1,B2 is now displayed in the top channel label field.

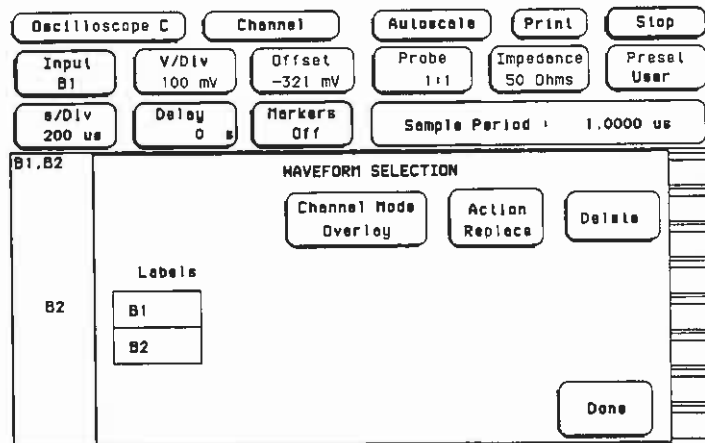

1. Touch the **Done** key in the pop-up.
2. Touch the **s/Div** field and change the sweep speed to 5 ns/div.
This will allow us to see the overlaid waveforms easier.

The display should now look like this. Input 2 (green) is now overlaid on Input 1 (yellow) in the top waveform display.

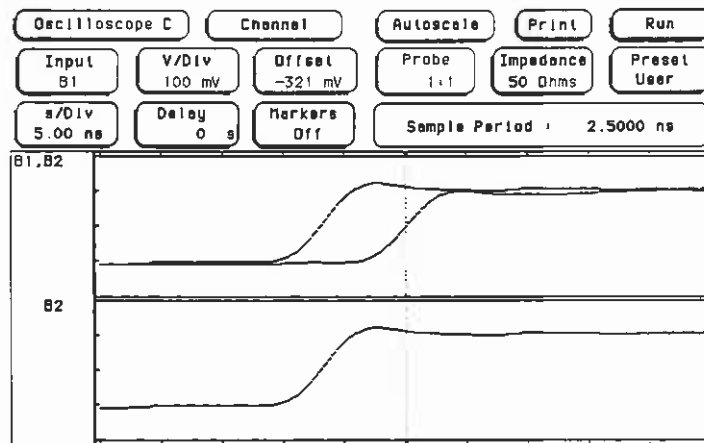

Touch the channel label field at the left of the waveform display to return to the **WAVEFORM SELECTION** pop-up.

**Waveform Math
(Chan+Chan,
Chan-Chan)**

Suppose you wanted to take the signal from Input 2 and add it to or subtract it from the signal from Input 1. Let's try subtracting Input 2 from Input 1. Touch the **Channel Mode** field on the display. When the pop-up appears, touch the **Chan - Chan** field.

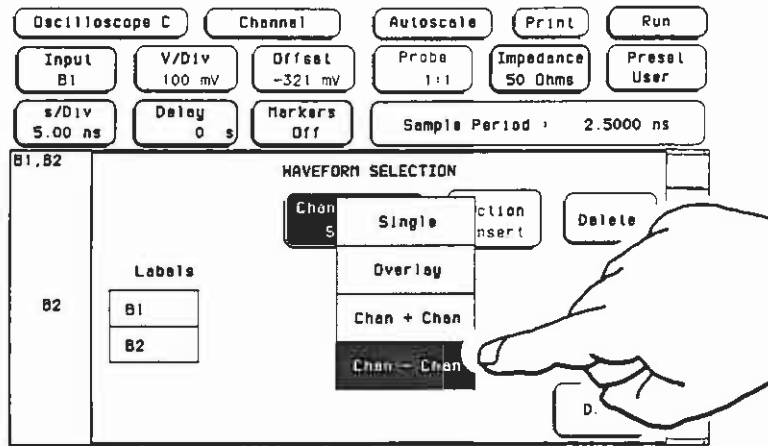

Let's subtract Input 2 from Input 1 in the bottom waveform display.

1. Turn the knob so that **B2** is highlighted in white.
2. Touch the **Action** field until **Replace** is displayed.
3. Touch the label **B1** in the pop-up, then touch the label **B2** in the pop-up. **B1-B2** is now displayed in the bottom channel label field.

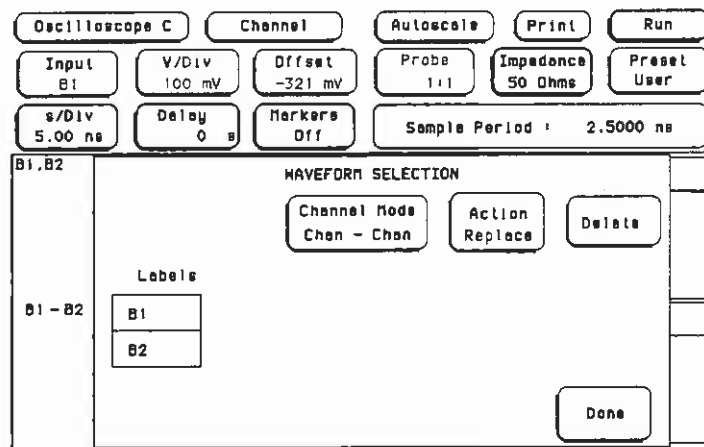

Touch the **Done** key in the pop-up. The display should now look like this:

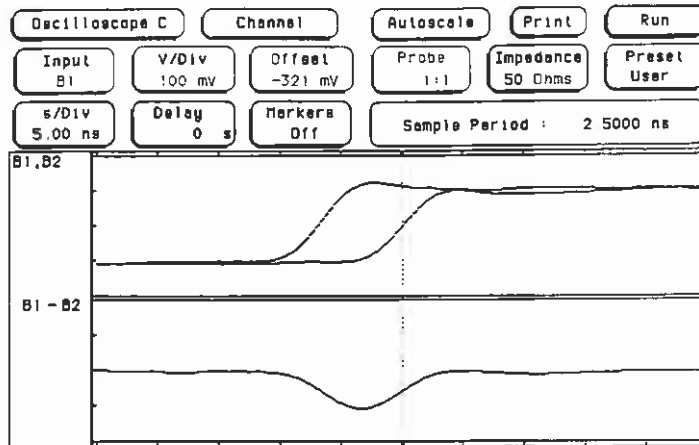

Input 2 has been subtracted from Input 1. The resultant waveform is displayed in white in the top waveform display. Notice now that both waveform overlay and A-B are displayed in the waveform display at the same time.

13

Saving and Recalling Setups

Introduction

You can store an oscilloscope configuration and all waveform display and measurement data to a floppy disc in the mainframe, then recall that information at a later time. Since the data is stored on floppy disc, you can store an unlimited number of configurations.

Besides recalling measurement data, recalling a configuration is a convenient way to return to a default condition without cycling the power on the mainframe.

You can also use the **Autoload** feature in the disc menu to automatically load a configuration other than the default oscilloscope configuration at power up.

Storing a Configuration

When you have an oscilloscope configuration you want to store to disc, you must go to a **System** disc menu to store the data. For this example, assume you are in an **Oscilloscope** menu.

1. Insert a floppy disc into either the front or rear disc drive of the mainframe. If the disc has not been formatted, do so at this time. Refer to the *HP 16500A Reference Manual*.
2. Touch the **Oscilloscope** module field in the upper left corner of the display, then select **System** from the pop-up.
3. Touch the menu field next to the **System** field and select either **Front Disc** or **Rear Disc** from the pop-up, depending on where you inserted the floppy disc.

A disc menu similar to that shown on the next page should be displayed. The list of files shown in this example are already stored on the disc.

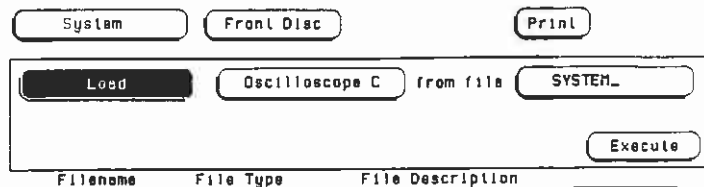

Filename	File Type	File Description	
SYSTEM_	16500A_system	HP16500A System Software	V00.01
SYSTEM_001	001_system	1 GHz Timing Analyzer	V00.01
SYSTEM_011	16530A_system	400MSample/s Dig. Scope	V00.01
SYSTEM_021	021_system	50Mbit/s Pattern Gen.	V00.01
SYSTEM_031	031_system	25MHz State/100MHz Timing	V00.01

Choose the **Store** operation from the disc menu.

1. Touch the disc operation field at the left of the display (**Load** in this example).
2. Select **Store** from the pop-up.

Store the configuration for the oscilloscope module only.

1. Touch the module field to the right of the **Store** field.

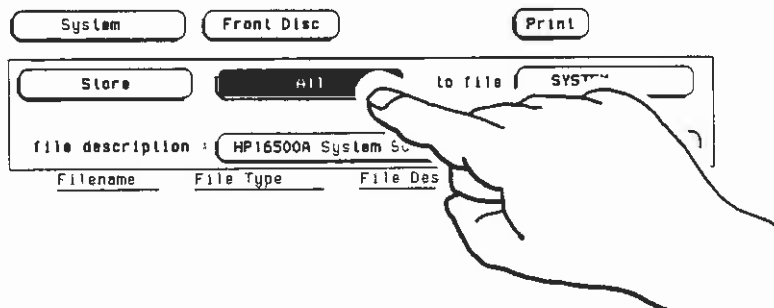

Filename	File Type	File Description	
SYSTEM_	16500A_system	HP16500A System Software	V00.01
SYSTEM_001	001_system	1 GHz Timing Analyzer	V00.01
SYSTEM_011	16530A_system	400MSample/s Dig. Scope	V00.01
SYSTEM_021	021_system	50Mbit/s Pattern Gen.	V00.01
SYSTEM_031	031_system	25MHz State/100MHz Timing	V00.01

2. Select the **Oscilloscope** field in the pop-up. If you have two oscilloscope modules in the mainframe (dual timebase), make sure you select the one you want to save the configuration for.

Enter a filename to save the configuration to.

1. Touch the field to the right of **to file** and a pop-up keyboard will appear.
2. Enter the name of a file. The filename must start with a letter and can contain up to eight characters with no blank spaces between characters. In this example, touch the appropriate keys to enter the filename **SCOPE1**. If you make a mistake, turn the knob to move the cursor to the incorrect entry, then touch the correct character on the keypad. Or if you want, touch the **CLEAR** key and start over again.
3. When you have entered the filename, touch the **DONE** field in the pop-up to return to the disc menu.

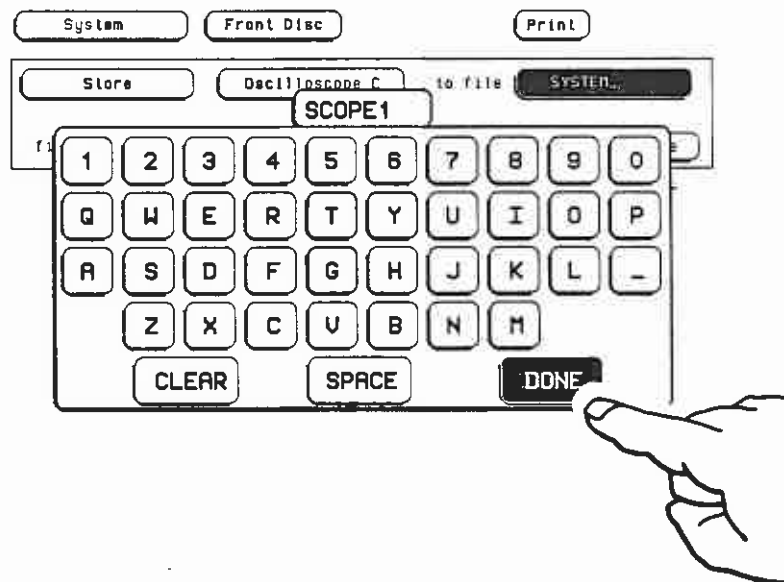

Notice that the filename you entered is appended with an underscore character and the letter of the mainframe slot the oscilloscope timebase board is in.

Note

*If you enter the name of a file that already exists on the disc, the oscilloscope will display **STORE WILL OVERWRITE SELECTED FILE(S)**.*

Enter a file description.

1. Touch the field to the right of file description and a pop-up keypad will appear.

Note

*Entering a file description is optional and for your convenience. This description will make it easier for you to identify the type of data in each file. If you do not want to enter a description, touch the **CLEAR** field in the pop-up, then touch the **DONE** field to return to the disc menu.*

2. Enter a description for the file. The description can be any combination of letters or numbers up to 32 characters long.
3. When you have entered the file description, make sure the description is correct since there is no way to change the description once the file has been saved. If the description is correct, touch the **DONE** field in the pop-up to return to the disc menu.

Store the file to disc.

CAUTION

*If you store a new configuration to an existing file, the new configuration is written over the original information and will **DESTROY** the original information in that file.*

1. Touch the **Execute** field.
2. Select **Continue** from the pop-up to store the file.

The file is now stored on the disc and is highlighted in the list of files on disc. The oscilloscope assigns file type **16530A_config** to the file. All oscilloscope configuration files saved to the disc will have this file type.

System Front Disc Print

Store Oscilloscope C to file SCOPE1_C

file description : COMP SIGNAL SETUP Execute

Filename File Type File Description

SCOPE1_C	16530A_config	COMP SIGNAL SETUP
SYSTEM_	16500A_system	HP16500A System Software V00.01
SYSTEM_001	001_system	1 GHz Timing Analyzer V00.01
SYSTEM_011	16530A_system	400MSample/s Dig. Scope V00.01
SYSTEM_021	021_system	50Mbit/s Pattern Gen. V00.01
SYSTEM_031	031_system	25MHz State/100MHz Timing V00.01

Loading a Configuration

When you have an oscilloscope configuration stored on disc that you want to load into the oscilloscope, you must go to the **System** disc menu to load the data. For this example, assume you in an **Oscilloscope** menu.

1. Insert the floppy disc that contains the stored configuration file into either the front or rear disc drive of the mainframe.
2. Touch the **Oscilloscope** module field in the upper left corner of the display, then select **System** from the pop-up.
3. Touch the menu field next to the **System** field and select either **Front Disc** or **Rear Disc** from the pop-up, depending on where you inserted the floppy disc.

A disc menu similar to that shown on the next page should be displayed.

The screenshot shows a graphical user interface for a disc menu. At the top, there are three buttons: "System", "Front Disc", and "Print". Below these is a larger menu area containing a "Load" button, an "All" button, the text "from file", a "SYSTEM_" button, and an "Execute" button. Below the menu area is a table header with three columns: "File Name", "File Type", and "File Description".

File Name	File Type	File Description
SCOPE1_C	16530A_config	COMP SIGNAL SETUP
SYSTEM_	16500A_system	HP16500A System Software V00.01
SYSTEM_001	001_system	1 GHz Timing Analyzer V00.01
SYSTEM_011	16530A_system	400MSample/s Dig. Scope V00.01
SYSTEM_021	021_system	50Mbit/s Pattern Gen. V00.01
SYSTEM_031	031_system	25MHz State/100MHz Timing V00.01

Choose the Load operation from the disc menu.

1. Touch the disc operation field at the left of the display if the Load field is not already displayed.
2. Select Load from the pop-up.

Load the configuration file for the oscilloscope module only.

1. Touch the module field to the right of the Load field.

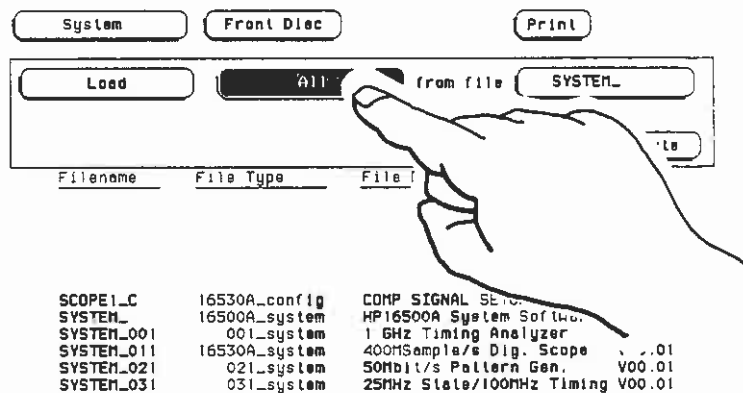

2. Select the Oscilloscope field in the pop-up. If you have two oscilloscope modules in the mainframe (dual timebase), make sure you select the one you want to load the configuration for.

Turn the knob to move the cursor to the file you want to load, then touch the Execute field to Load the configuration file into the oscilloscope.

The configuration file has now been loaded into the oscilloscope. The waveform data will stay in the oscilloscope memory the same as if it were acquired in the Single mode. As soon as you touch the Run field, the oscilloscope will acquire new waveform data.

Autoloading a Configuration

The Autoload feature in the **System** disc menu lets you automatically load a configuration other than the default oscilloscope configuration at power up. For this example, we will use the configuration file (**SCOPE1_C**) we stored at the beginning of the chapter for the autoload configuration.

1. Insert the floppy disc that contains the configuration file you want to use as an autoload file into either the front or the rear disc drive of the mainframe.
2. Touch the module key in the upper left corner of the menu, then select **System** from the pop-up.
3. Touch the menu field next to the **System** field and select either **Front Disc** or **Rear Disc** from the pop-up, depending on where you inserted the floppy disc.

A disc menu similar to that shown below should be displayed.

Filename	File Type	File Description
SCOPE1_C	16530A_config	COMP SIGNAL SETUP
SYSTEM_	16500A_system	HP16500A System Software V00.01
SYSTEM_001	001_system	1 GHz Timing Analyzer V00.01
SYSTEM_011	16530A_system	400MSample/s Dig. Scope V00.01
SYSTEM_021	021_system	50Mb/s Pattern Gen. V00.01
SYSTEM_031	031_system	25MHz State/100MHz Timing V00.01

Choose the Autoload operation from the disc menu.

1. Touch the disc operation field at the left of the display.

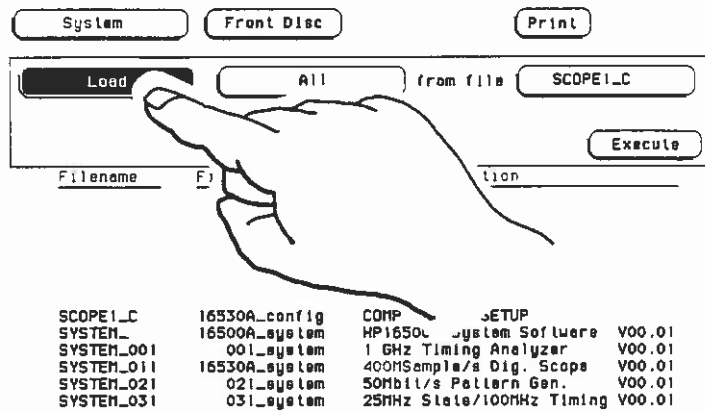

2. Select Autoload from the pop-up.

Enable the Autoload function.

1. Touch the **Disable** field next to the Autoload field.
2. Select **Enable** from the pop-up.

Turn the knob to move the cursor to the file you want to become the autoload file (**SCOPE1_C** in this example). The name in the field to the right of **File :** should be **SCOPE1_C**. Now touch the **Execute** field to enable **SCOPE1_C** as the autoload file.

The oscilloscope adds a new file named **AUTOLOAD** to the listing as shown below.

System
Front Disc
Print

Autoload
Enable
File : SCOPE1_C

Current AUTOLOAD status : ENABLED
 Current AUTOLOAD file : SCOPE1_?

Execute

Filename	File Type	File Description
AUTOLOAD	autoload_file	status: ENABLED file: SCOPE1_?
SCOPE1_C	16530A_config	COMP SIGNAL SETUP
SYSTEM_	16500A_system	HP16500A System Software V00.01
SYSTEM_001	001_system	1 GHz Timing Analyzer V00.01
SYSTEM_011	16530A_system	400MSample/s Dig. Scope V00.01
SYSTEM_021	021_system	50Mbit/s Pattern Gen. V00.01
SYSTEM_031	031_system	25MHz State/100MHz Timing V00.01

Two status lines are displayed under the Autoload field. The first line gives the status of Autoload (ENABLED), and the second line give the file name of the autoload file (SCOPE_?). The question mark (?) after the filename indicates that all files that start with the characters **SCOPE_** will be loaded at power-on when Autoload is enabled. This allows you to autoload configurations for any number of modules as long as the file names are the same. The letter at the end the file name tells the mainframe which slots the modules are located in.

As long as Autoload is enabled before the Instrument is shut off, Autoload will remain enabled when you power-up the instrument and the autoload configuration file(s) will be loaded.

To disable the Autoload operation:

1. Touch the **Enable** field next to **Autoload**, and select **Disable** from the pop-up.
2. Touch the **Execute** field.

Autoload is now disabled. The status of the **AUTOLOAD** file is now **DISABLED**.

Filename	File Type	File Description
----------	-----------	------------------

AUTOLOAD	autoload_file	status: DISABLED
SCOPE1_C	16530A_config	COMP SIGNAL SETUP
SYSTEM_	16500A_system	HP16500A System Software V00.01
SYSTEM_001	001_system	1 GHz Timing Analyzer V00.01
SYSTEM_011	16530A_system	400MSample/s Dig. Scope V00.01
SYSTEM_021	021_system	50Mbit/s Pattern Gen. V00.01
SYSTEM_031	031_system	25MHz State/100MHz Timing V00.01

14

Using a Printer

Setting Printer Configuration

All printer parameters are set in the **System Configuration** menu. If you have just connected your printer and are unsure of how to set the configuration, refer to the *HP 16500A Reference Manual* chapter entitled *Connecting a Printer*.

The HP 16500A supports HP-IB and selected RS-232C printers.

All the pictures in this manual were taken from an HP 16500A with one HP 16530A timebase card and one HP 16531A acquisition card. If the screens on your instrument differ from the pictures in this manual, it simply means that you have a different card configuration. All other functions will work the same except where noted.

Printing Options

All oscilloscope menus include a **Print** field in the upper right of the screen.

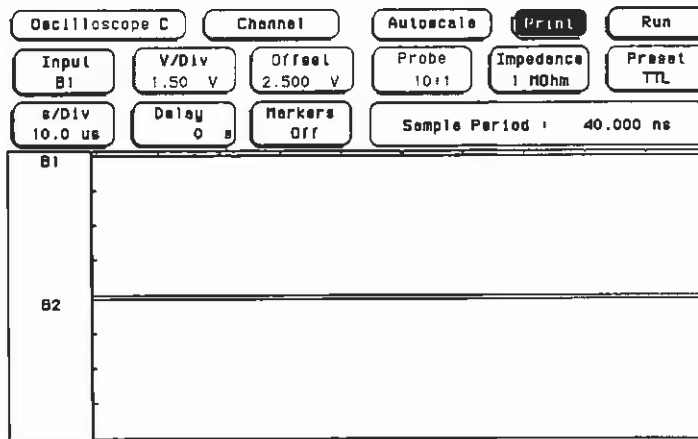

When you touch the **Print** field, a pop-up like the one shown below appears.

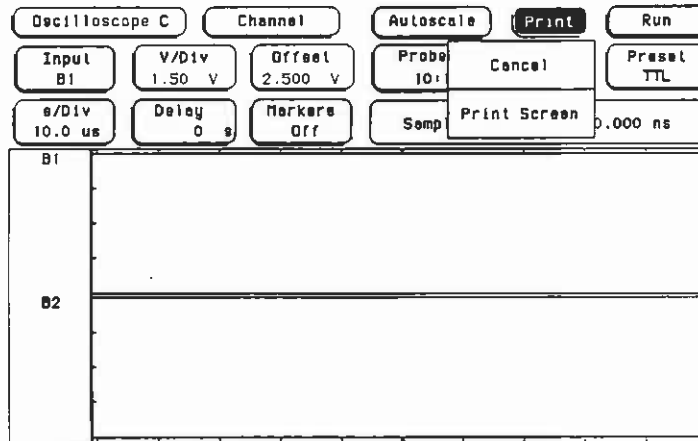

There are two fields in the pop-up, **Cancel** and **Print Screen**. If you touch the **Cancel** field, the print will be cancelled.

Printing On-Screen Data

If you want a hardcopy record of the screen, touch the **Print** field and then the **Print Screen** field from the pop-up. This will send a copy of the screen to the printer in graphics mode. When the print is complete, the advisory **Print Completed** is displayed.

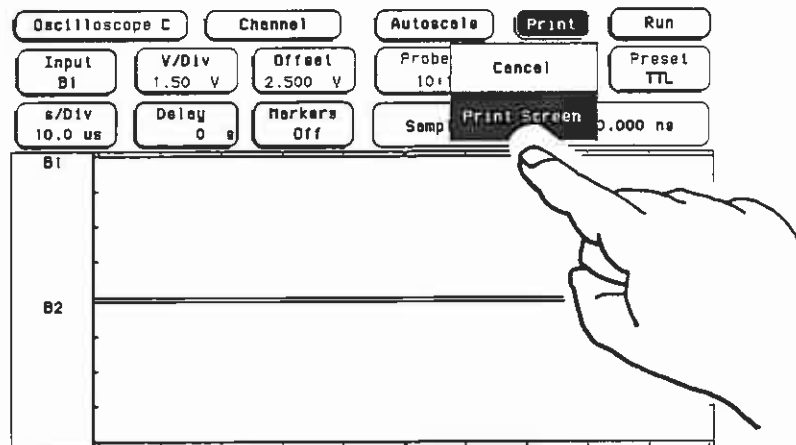

15

Using a Dual-Timebase Oscilloscope

Introduction

The HP 16500A can be configured as a dual-timebase oscilloscope by installing two HP 16530A/16531A oscilloscope modules into the mainframe. The oscilloscope are installed as two independent instruments -- two timebase cards, with each timebase card having an acquisition card. If the fifth mainframe slot does not contain another instrument module, an additional acquisition card can be added to one of the timebase cards. For more information on installing oscilloscope modules, refer to chapter 16, "Installing New Oscilloscope Boards into the Mainframe".

In this chapter, we will show you how to configure and make a measurement using a dual-timebase oscilloscope. In this example, one oscilloscope module is installed in slots B and C, and the other oscilloscope module is installed in slots D and E. The module field pop-up will display the modules as **Oscilloscope C** and **Oscilloscope E**.

When the mainframe is first powered up, the default **System Configuration** menu will look like the display shown below.

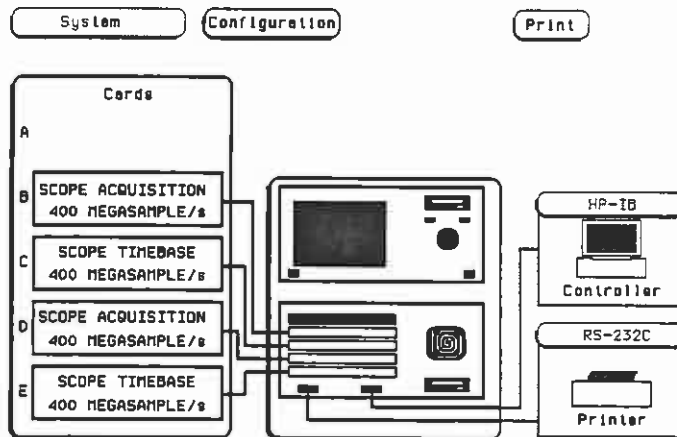

Setting Up the Intermodule Menu

Any time one module must be configured to arm another module, the connection must be made using the **Intermodule** menu. For this example, we will configure Oscilloscope C to arm Oscilloscope E. If you need additional information on the **Intermodule** menu, refer to "Intermodule Measurements" in the *HP 16500A Logic Analysis System Reference Manual*.

Go to the **Intermodule** menu and configure the oscilloscope modules.

1. Touch the module menu key in the upper left corner of the display. A pop-up will appear showing **System**, **Intermodule**, and the two oscilloscope modules.
2. Select **Intermodule** from the pop-up. The **Intermodule** menu will appear like the display shown below.

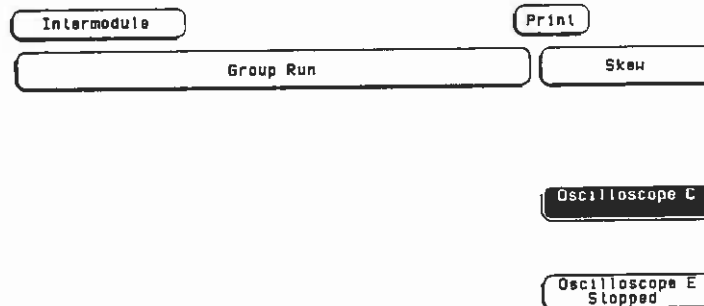

3. Touch the **Oscilloscope C** field. A pop-up appears allowing you to configure **Oscilloscope C** to run independently or to group run with other modules.

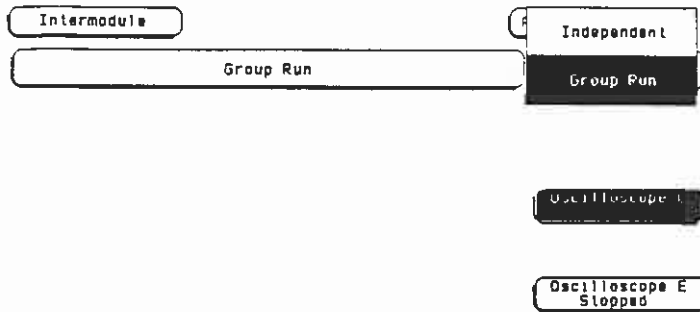

4. Select **Group Run** from the pop-up. A yellow box with the letter **C** is now displayed under the large blue **Group Run** field. A new green **Group Run** field appears in the upper right corner of the display. This field will now replace the normal green **Run** field in the oscilloscope menus.

5. Touch the **Oscilloscope E** field. A pop-up will appear as shown below. This pop-up has an additional field. You can now specify oscilloscope C to arm oscilloscope E.

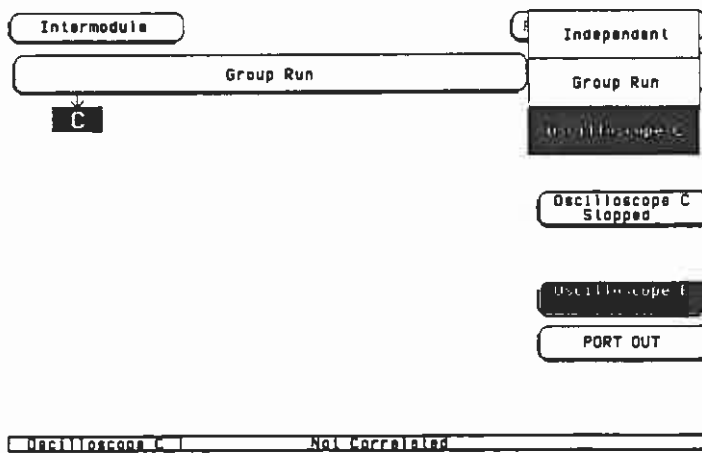

6. Select **Oscilloscope C** from the pop-up. A yellow box with the letter E appears below the yellow C box. This tells you that Oscilloscope C will arm Oscilloscope E will Oscilloscope C triggers.

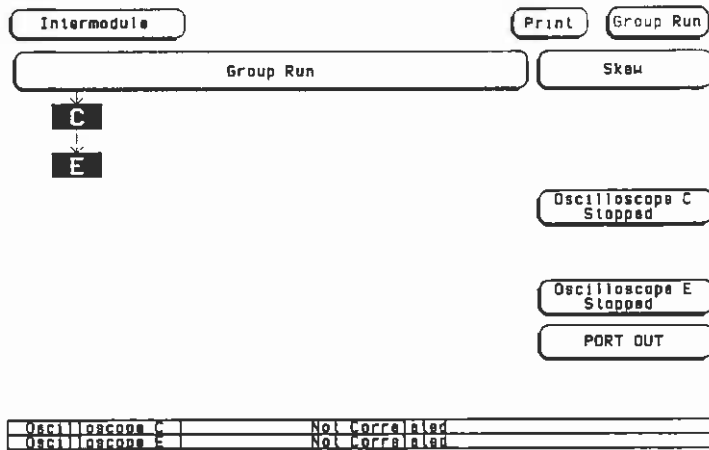

Status Both oscilloscope fields in the **Intermodule** menu display the run/stop status of the oscilloscope module. At this point, both oscilloscope modules display **Stopped**.

Time Correlation Bars The two light-blue fields at the bottom of the display are time correlation bars. When the oscilloscopes are running and acquiring data, these bars display the start and stop time of Oscilloscope C in relation to Oscilloscope E. At this time the oscilloscopes are not running and no time relationship is displayed.

Skew Touch the **Skew** field. A pop-up appears which allows you to adjust skew between the oscilloscope modules. This adjustments allows you to compensate for variances in internal probing delays between oscilloscope modules.

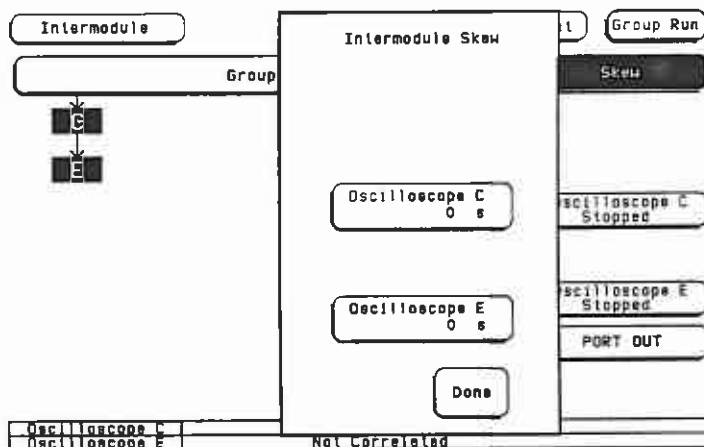

To determine the value of skew time to be entered, use the **Markers On** field in any of the oscilloscope menus. Measure the time between the edge of a waveform on Oscilloscope C and the edge on the same signal on an input to Oscilloscope E. The time difference between the two edges is the skew value you should enter. A positive time value moves the waveform for that oscilloscope to the right and a negative value moves the waveform to the left. In this example, since Oscilloscope C is arming Oscilloscope E, the trigger point is set by Oscilloscope C. Since Oscilloscope C is the reference for trigger, change the skew time of Oscilloscope E.

To adjust the skew between oscilloscopes, touch either oscilloscope field in the pop-up menu and turn the knob. Resolution is 1 ns for times up to 99.999 us, and can be set to 5-digit resolution at times above 99.999 us. Skew can also be set by using the pop-up keypad. The keypad will appear when you touch either **Oscilloscope** field when the field is light blue.

Setting Up the Oscilloscopes

Set up the oscilloscope modules as described in the following paragraphs.

- Connect a Signal**
1. Connect a BNC tee to the COMPENSATION SIGNAL output of either of the timebase cards at the rear of the instrument.
 2. Connect a BNC cable from the BNC tee to INPUT 1 of the acquisition card in slot B.
 3. Connect a BNC cable from the BNC tee to INPUT 1 of the acquisition card in slot D.

- Acquire a Waveform with Oscilloscope E**
1. Touch the **Intermodule** field and select **Oscilloscope E** from the pop-up.
 2. Touch the **Autoscale** field and select **Continue** from the pop-up. The compensation signal should now be displayed on **D1**.
 3. Select the **s/Div** field and set the sweep speed to 20 us/div.

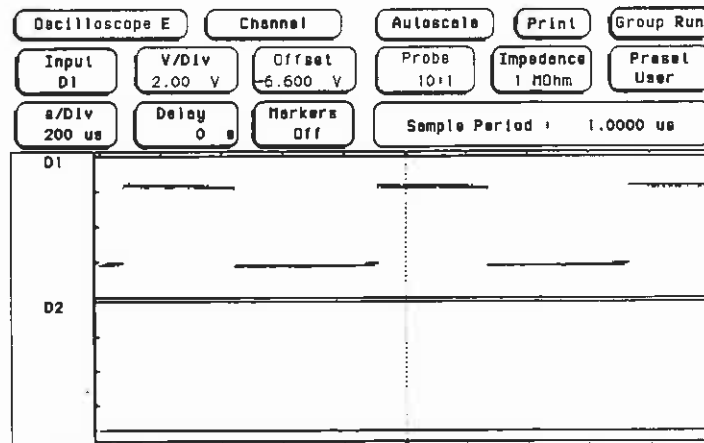

Set the Trigger Mode

Since Oscilloscope E is armed by Oscilloscope C, you need to set the trigger mode of Oscilloscope E to **Immediate**. Immediate trigger mode allows Oscilloscope E to trigger immediately after Oscilloscope C receives its trigger. If not set to **Immediate**, Oscilloscope C would wait to trigger on an edge or pattern condition.

1. Go to the **Trigger** menu.
2. Touch the **Mode** field and select **Immediate** from the pop-up.

Note

*Anytime you autoscale a signal, the trigger mode is automatic set to **Edge** trigger mode. Make sure you set trigger mode back to **Immediate** before continuing.*

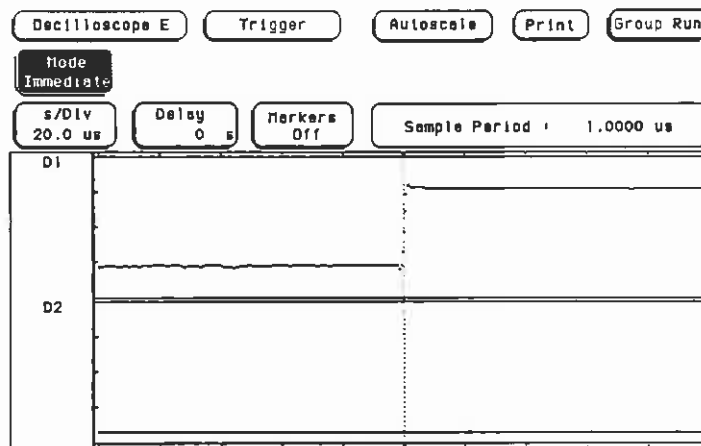

Add Input Labels

1. Go to any **Oscilloscope C** menu and touch the channel label field to select the **Waveform Selection** pop-up. Notice that a field not normally present in this pop-up is displayed. The new **Module** field allows you to add labels from Oscilloscope E to the channel label field.

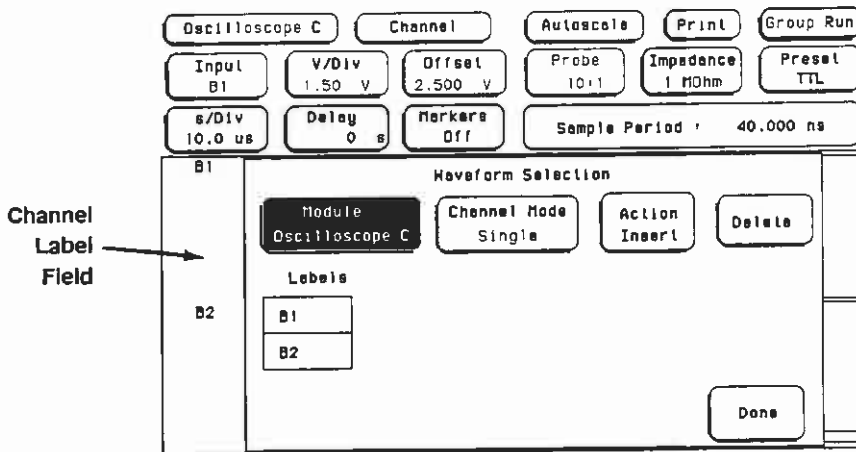

2. Touch the **Module** field and select **Oscilloscope E** from the pop-up. Notice that the labels under the **Module** field have changed from **B1** and **B2** to **D1** and **D2**.
3. Turn the knob to move the highlight to **B2** in the channel label field. Touch the **Delete** field to delete **B2**.
4. Touch the **Action** field until **Insert** is displayed. Now touch label **D1** to insert **D1** into the channel label field.
5. The display should now look like the one shown at the top of the next page. Touch **Done** to return to the oscilloscope menu.

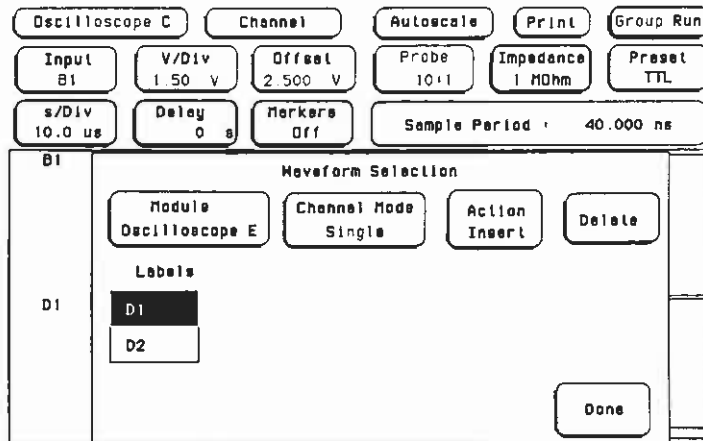

B1 and **D1** are now displayed in the channel label field. No waveforms are displayed and the **D1** waveform area displays the advisory **Not Correlated** since no waveform data has been acquired.

Acquire Waveforms

Touch the **Autoscale** field, then select **Continue** from the pop-up. Waveforms have now been acquired on both input channels **B1** and **D1**.

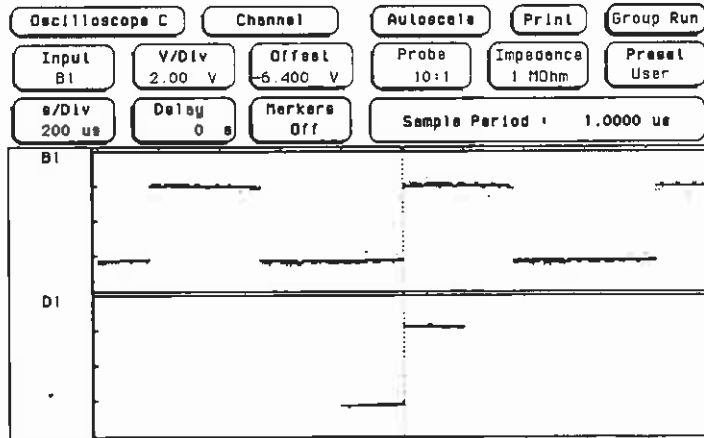

Notice the waveform for input **D1** is compressed in the waveform display. **B1** was acquired at 200 us/div. **D1** was acquired at 20 us/div.

Select **s/Div**, then turn the knob to set the sweep speed to 200 ns/div. Dual-timebase allows you to acquired waveforms at different sweep speeds, then examine the data in further detail by changing sweep speed and delay time.

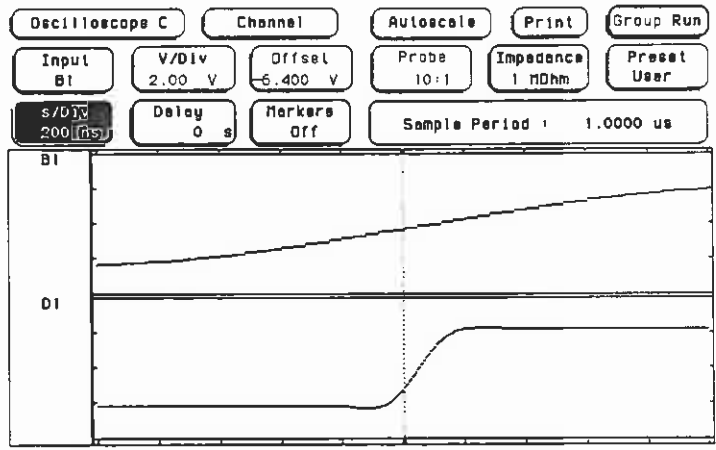

Time Correlation Bars

Touch the **Oscilloscope C** module field in the upper left corner of the display, then select **Intermodule** from the pop-up. Notice the time relationship of Oscilloscope C to Oscilloscope E in the time correlation bars at the bottom of the display. This reflects the relationship of the sweep speeds (20 us/div and 200 us/div) of the two oscilloscope modules.

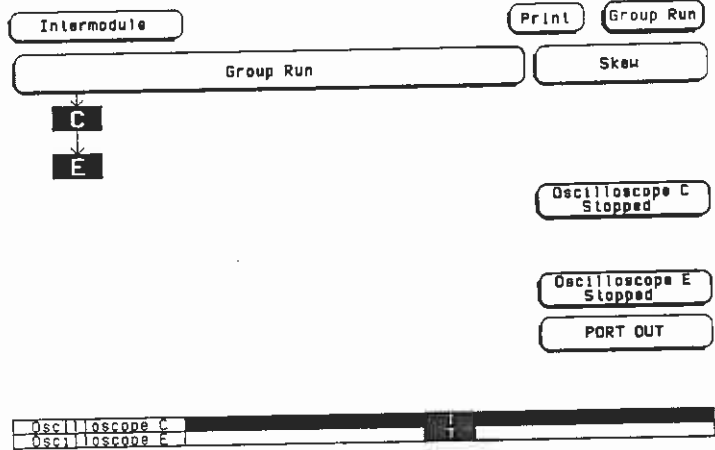

16

Calibration Menu

Introduction

This section provides information on when and how to calibrate the digitizing oscilloscope module.

Calibration Interval

The HP 16530A/31A Oscilloscope Module can be calibrated from the front panel without access to the interior of the instrument. This procedure sets the oscilloscope calibration factors and stores them on the operating disc in a file named **CAL_FACT_X**, where X is the slot (B, C, D, or E) in the mainframe where the timebase card is installed.

To maintain proper calibration, this calibration should be performed at approximately two year intervals when the instrument is being used under normal operating conditions. If the instrument is used more than one shift per day the calibration interval may need to be shorter. Immediate calibration is required if one of the following occurs:

- Oscilloscope module is installed or replaced
- Operating disc is changed
- Card configuration is changed
- Oscilloscope module is repaired
- Ambient temperature changes more than 10° C

Before the the adjustment procedures in section IV of the *HP 16530A/31A Service Manual* are performed, the oscilloscope should be calibrated using the **Calibration** menu, then the performance tests in section III of the *HP 16530A/31A Service Manual* should be done. If the performance tests are within specifications, then adjustments are not necessary.

If either card is repaired, the oscilloscope module should be adjusted. New modules are pre-adjusted at the factory to meet the specifications in Appendix B. If adjustments are required, refer to section IV of the *HP 16530A/31A Service Manual*.

Calibration Menu Map

The menu map for the Calibration menu is shown below.

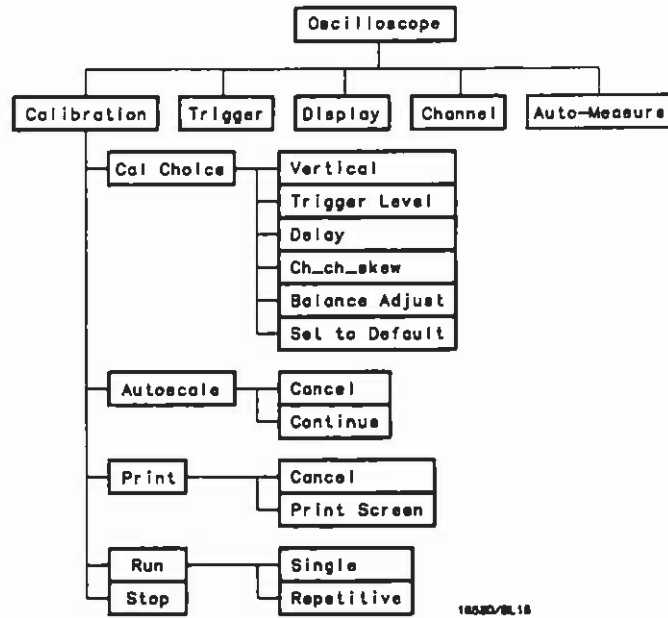

Instrument Warmup

Calibrate the Instrument at it's environmental ambient temperature and after a 15 minute warm-up.

Calibration Menu

The Calibration menu allows you to perform automatic calibration procedures. When the calibration procedures are performed, the results are automatically stored on floppy disc. The default Calibration menu is shown below.

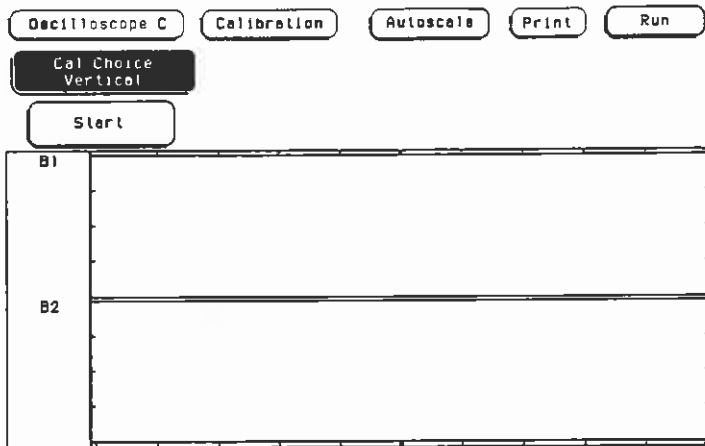

When you touch the Cal Choice field, a pop-up appears showing all the calibration choices. Balance Adjust and Set to Default fields in the pop-up are service functions used in adjustment procedures. Refer to adjustment section IV in the *HP 16530A/31A Service Manual* for further information.

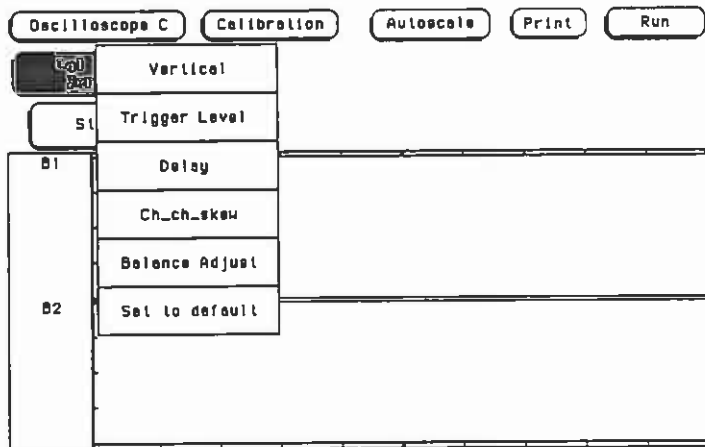

Maintaining Calibration Integrity

Calibration factors depend on the system disc, mainframe, acquisition cards and module configuration all staying together. If the system disc or acquisition cards are interchanged between mainframes or the oscilloscope module is moved to different slots in the mainframe, calibration must be repeated. In an environment in which the possibility of sharing oscilloscope modules and system discs exist, we recommend taking the following precautions in order to maintain calibration integrity:

1. Install oscilloscope module in bottom slots.
2. Boot system using rear disc drive.
3. Perform calibration procedures in **Calibration** menu.
4. Seal oscilloscope module to mainframe.
5. Remove floppy disc and write protect it.
6. Reinstall floppy disc and seal it in the rear disc drive.

Calibration Prerequisites

The calibration procedures in this section should be followed in their entirety and in the following sequence:

1. **Vertical**
2. **Trigger Level**
3. **Delay**
4. **Ch_ch_skew**

When calibrating the HP 16530A/31A Oscilloscope Module, the cards must be installed in the instrument and the instrument covers and filler panels must be in place.

Calibration factors for all calibrations except channel-to-channel skew are stored on the system disc in a file named **CAL_FACT_X**, where X is the slot (B, C, D, or E) in the mainframe where the timebase card is installed. The channel-to-channel skew is stored only when the oscilloscope's measurement parameters are stored in a configuration file.

Before starting these procedures, make sure the system disc is inserted in either of the mainframe disc drives.

Vertical Calibration

A known offset voltage internal to the instrument is digitized. The preamplifier gain and offset are then corrected to obtain digitized data equivalent to the known input voltage.

- Procedure**
1. Disconnect signals from all inputs on the acquisition card(s).
 2. Touch the **Cal Choice** field.
 3. Select the **Vertical** field from the pop-up.

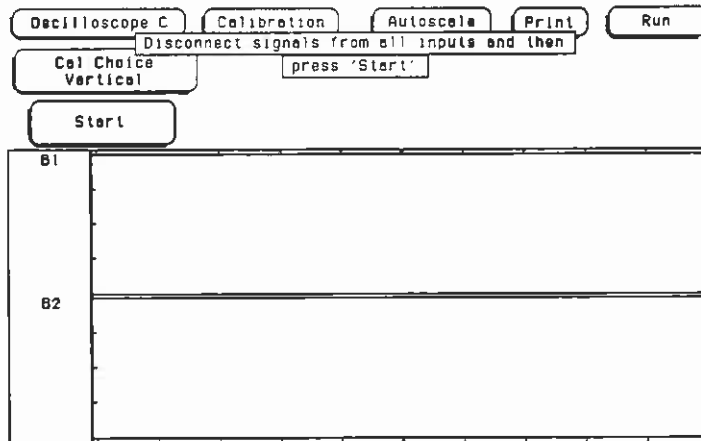

4. Touch the **Start** field.

While the vertical calibration is being performed, the following advisories are displayed on screen, in this order.

Vertical cal is in progress

Vertical calibration on X1 is completed, where X = mainframe slot

Vertical calibration on X2 is completed, and so on for all inputs

Vertical cal completed

Storing cal factors on disc

Storing cal factors completed

The vertical calibration factors have now been stored on the floppy disc.

Trigger Level Calibration

A known offset voltage internal to the instrument is digitized. The trigger level is then corrected to trigger at the input voltage.

- Procedure**
1. Disconnect signals from all inputs on the acquisition card(s).
 2. Touch the **Cal Choice** field.
 3. Select the **Trigger Level** field from the pop-up.

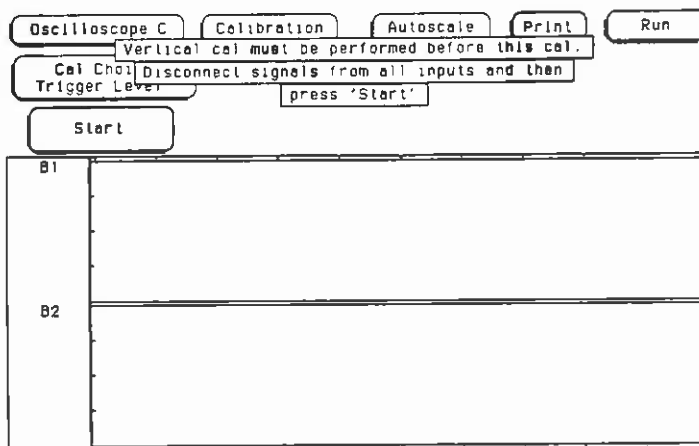

4. Touch the **Start** field.

While the trigger level calibration is being performed, the following advisories are displayed on screen, in this order.

Trigger cal is in progress

Trigger level calibration on X1 is completed, where X = mainframe slot

Trigger level calibration on X2 is completed, and so on for all inputs

Trigger level cal completed

Storing cal factors on disc

Storing cal factors completed

The trigger level calibration factors have now been stored on the floppy disc.

Delay Calibration

The rising edge of the COMPENSATION SIGNAL output is set to Time = 0 (midscreen) for each input.

- Procedure**
1. Touch the **Cal Choice** field.
 2. Select the **Delay** field from the pop-up.

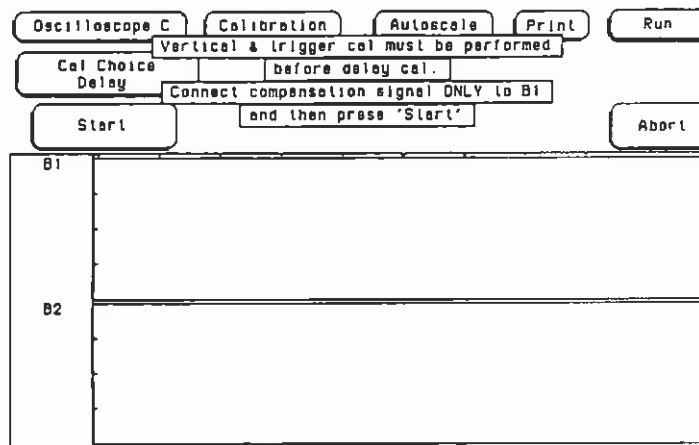

3. Connect a BNC cable from the COMPENSATION SIGNAL output on the timebase card to the acquisition card input shown in the green advisory message.
4. Touch the **Start** field.

When the delay calibration on the first input is completed the following advisory is displayed on screen:

**Delay cal passed on X1, where X = mainframe slot
Connect compensation signal ONLY to X2
and then press 'Start'**

If additional acquisition cards are installed, advisories will continue to be displayed telling you which input to connect the compensation signal to. Follow the instructions displayed on screen until all inputs have been delay calibrated. When delay calibration is complete, the following advisories will be displayed:

**Delay cal completed
Storing cal factors completed**

The delay calibration factors have now been stored on the floppy disc.

Channel-to-Channel Skew

The channel-to-channel skew adjustment nulls any time delays caused by the lead lengths of the probes or cables used for a measurement. INPUT 1 of one of the acquisition cards is used as the reference against which all other channels are nullled.

Channel-to-channel skew calibration factors are not automatically stored to the system disc. These factors are only stored when you save an oscilloscope configuration to a disc. See chapter 13 "Saving and Recalling Setups" for more information.

Note

This procedure uses the compensation signal and BNC cables to simulate a signal and probes. Consider this procedure as an example only. In this example, acquisition cards are shown in mainframe slots B and C and a timebase card in slot D.

- Procedure** 1. Go to the **Display** menu and change the **Mode** field to **Average**. Set **Average #** to 4.

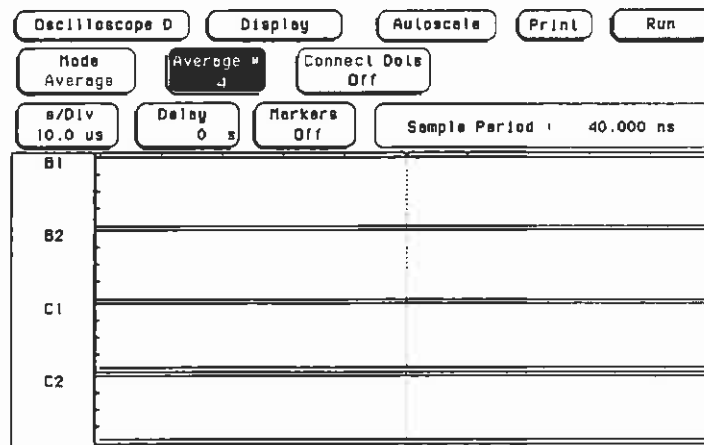

2. Go to the **Channel** menu and change the **Impedance** field to **50 Ohms** for all inputs that you want calibrated. Inputs are selected by touching the **Input** field in the **Channel** menu.

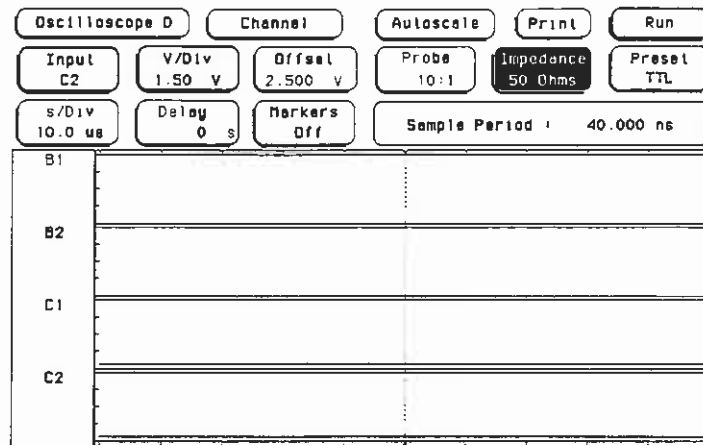

3. Overlay all inputs you want calibrated on one waveform display.
 - a. Touch the channel label field and the **WAVEFORM SELECTION** pop-up menu will appear.
 - b. Touch the **Channel Mode** field, then select the **Overlay** field from the pop-up.
 - c. Delete all input labels by touching the **Delete** field until all labels in the channel label field are gone.
 - d. Touch the **Action** field until **Insert** is displayed in the field.
 - e. Touch each input in the **Label** field until all inputs are overlaid together in the channel label field.
 - f. Touch the **Done** field when you are finished. The display should now look similar to the screen on the following page.

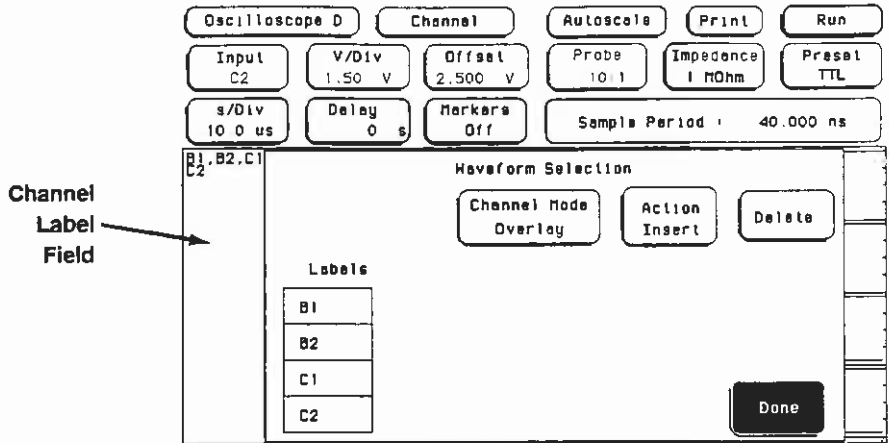

- Using two BNC cables of equal length and a BNC tee, connect COMPENSATION SIGNAL output from the timebase card as shown below to INPUT 1 and INPUT 2 of the top acquisition card. For your reference, the figure below shows four acquisition cards installed in the mainframe. INPUT 1 of the top acquisition card will be the reference for all other channels. INPUT 2 of the top acquisition card will be the first channel to be calibrated.

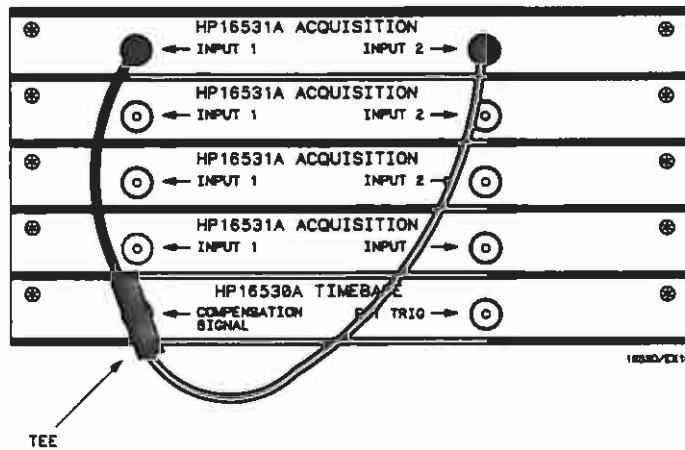

5. Touch the **Run** field and drag your finger to the **Repetitive** field in the pop-up.
6. Touch the **Autoscale** field, then select **Continue** from the pop-up.
7. Touch the **s/Div** field and turn the knob to set the sweep speed to 5 ns/div. The display should now look similar to screen shown below. Reference input **B1** is the yellow waveform.

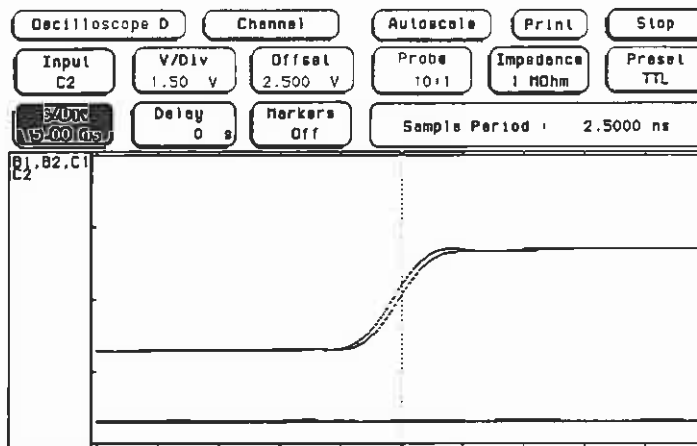

8. Go to the **Calibration** menu.
9. Turn the knob until both waveforms are overlaid at approximately the 50% point.

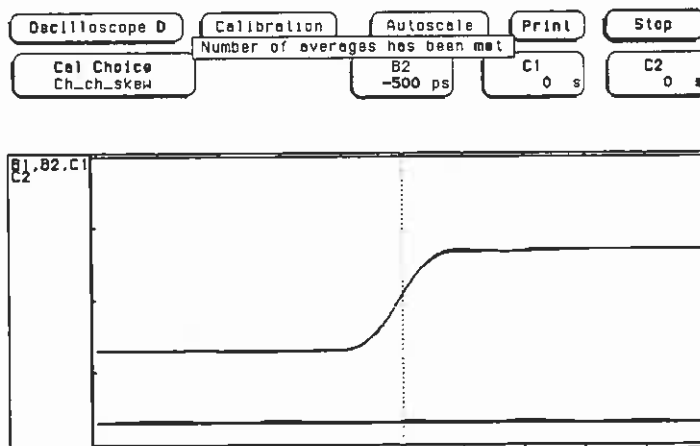

10. If there are multiple acquisition cards, leave the compensation signal connected to the reference input and move the other BNC cable to the next Input to be calibrated as shown below.

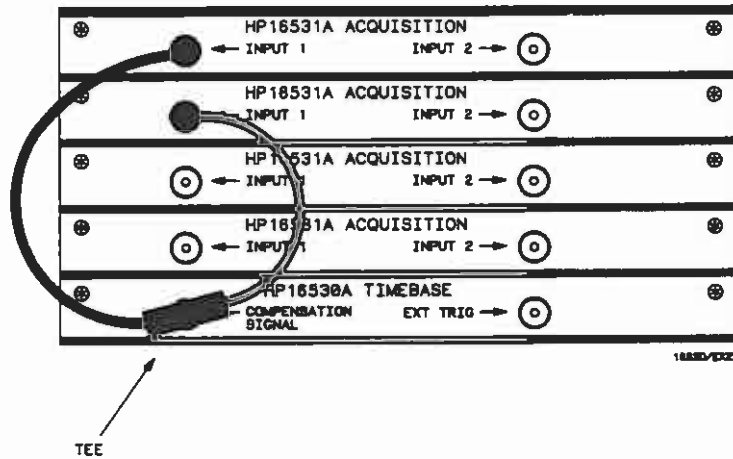

11. Touch the label of next channel to be calibrated as shown below.

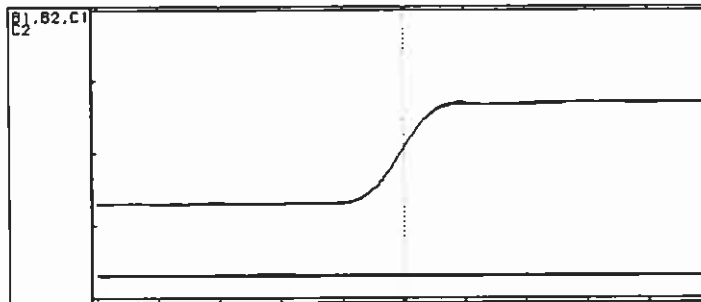
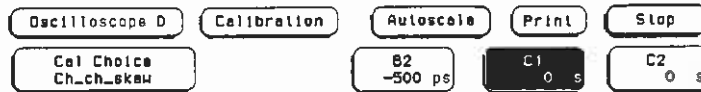

12. Repeat steps 6 through 11 until all channels are calibrated to the reference channel. The s/Div field appears in any oscilloscope menu except Calibration.

A

Installing New Oscilloscope Boards into the Mainframe

Introduction

This chapter explains how to add additional oscilloscope cards to the mainframe. Also included is initial inspection, preparation for use, storage, and shipment.

Initial Inspection

Inspect the shipping container for damage. If the shipping container or cushioning material is damaged, it should be kept until the contents of the shipment have been checked for completeness and the module has been checked mechanically and electrically. The contents of the shipment should be as listed in "Accessories Supplied" in Chapter 1.

If the contents are incomplete, if there is mechanical damage or a defect, or if the instrument does not pass the performance tests, notify the nearest Hewlett-Packard office. Procedures for checking electrical performance are given in Section III of the *HP 16530A/31A Service Manual*.

If the shipping container is damaged, or the cushioning material shows signs of stress, notify the carrier as well as the Hewlett-Packard office. Keep the shipping material for carrier's inspection. The Hewlett-Packard office will arrange for repair or replacement at Hewlett-Packard's option without waiting for claim settlement.

Power Requirements

All power supplies needed to operate the HP 16530A/31A Oscilloscope Module are supplied to the cards through the backplane connector of the HP 16500A Logic Analysis System mainframe.

Dual Timebase Installation

If you want to configure the mainframe with a dual-timebase oscilloscope, follow the installation instructions. Each timebase/acquisition card set is considered to be a separate oscilloscope module. No interconnecting cables are required between the two modules.

Installation

CAUTION

Do not install, remove or replace the module in the instrument unless the instrument power is removed.

The HP 16530A/31A Oscilloscope Module consists of two or more cards. The HP 16530A Timebase Card may have as many as four HP 16531A Acquisition Cards connected to it. For every additional acquisition card connected, an extra slot will be used in the card cage. Procedures for installing the oscilloscope module and adding acquisition cards are shown in the step-by-step procedure in the following paragraphs.

Module Installation

The following procedure is for the installation of the HP 16530A/31A Oscilloscope Module. If the system already has an HP 16530A/31A Oscilloscope Module installed, and you are adding additional acquisition cards, follow the "Adding Acquisition Cards" procedure later in this section.

Installation Considerations

- Acquisition cards must be positioned above the timebase card.
- Use one cable per acquisition card. See figure A-2.
- If there are not enough empty slots to install the module correctly, existing modules must be repositioned in card cage.
- Cards below the slots to be filled by oscilloscope module do not have to be removed.

CAUTION

The effects of ELECTROSTATIC DISCHARGE can damage electronic components. Grounded wriststraps and mats should be used when you perform any kind of service to this instrument or the cards in it.

- Procedure**
- a. Turn Instrument power switch off, unplug power cord and disconnect any Input BNCs.
 - b. Starting from the top of the Instrument rear panel, loosen thumb screws on filler panel(s) and card(s).
 - c. Starting from the top, begin pulling card(s) and filler panel(s) out half way. See figure A-1.

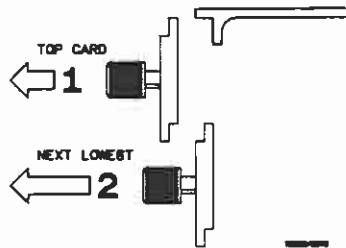

Figure A-1. Endplate Overhang

CAUTION

Some modules are hooked together by intercard connecting cables.

- d. Noting "Installation Considerations" on page A-2, use figure A-2 to plan the card configuration and cable connection.

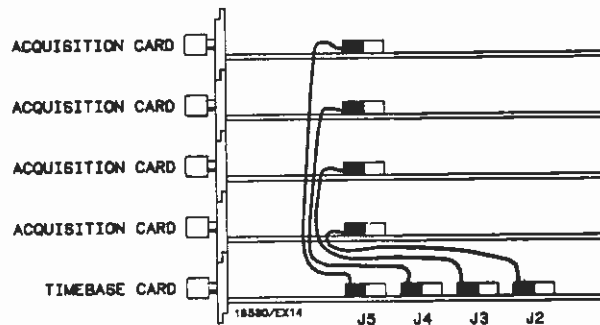

Figure A-2. Card and Cable Configuration

- e. Remove the filler panels covering the slots to be filled by the oscilloscope module.
- f. Push all other card(s) into the card cage, but not completely in, so they won't be in the way when you install the scope module.
- g. Install one cable per acquisition card into the correct timebase card connector (see figure A-2), making sure to install the correct cable end. Use figure A-3 to identify the correct cable end.

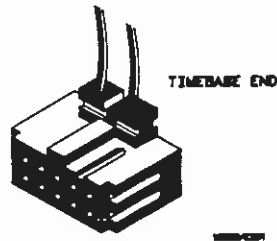

Figure A-3. Cable End

- h. Lay cable(s) flat and pointing out to rear of card. See figure A-4.

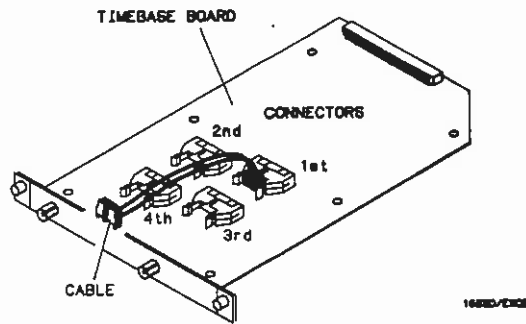

Figure A-4. Cable Position

- i. Slide timebase card approximately **half way** into lowest slot being used for the oscilloscope module.
- j. Slide acquisition card in **half way**, feeding cable up through square hole in acquisition card.
- k. Plug in other end of cable to connector on acquisition card. See figure A-5.
- l. If you have additional acquisition cards, repeat steps j through i until all cards are in **half way** and all cables are connected.

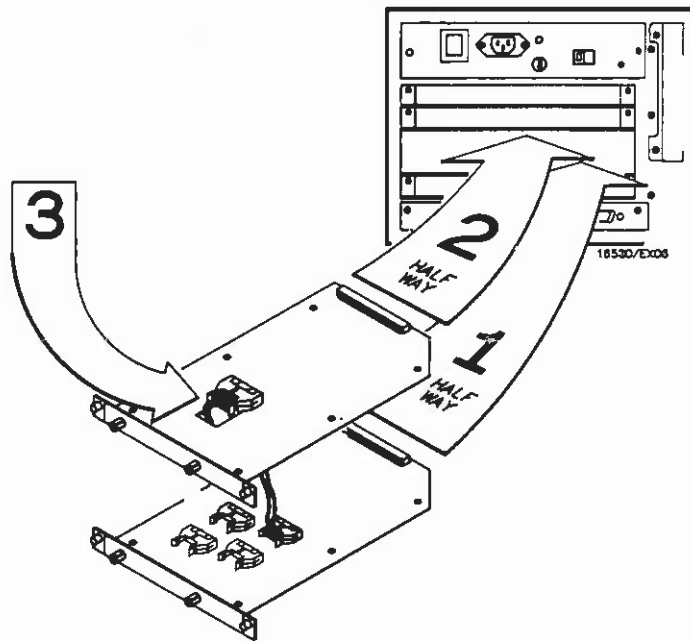

Figure A-5. Installation Summary

- m. Firmly seat bottom card into backplane connector. **Keep applying pressure to the center of card endplate while tightening thumb screws finger tight.**
- n. Repeat for all cards and filler panels in a bottom to top order. See figure A-6.

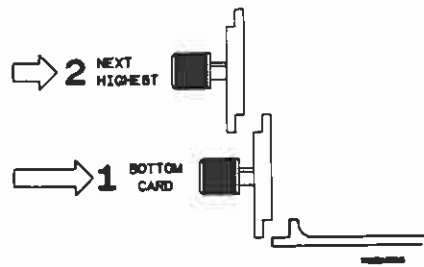

Figure A-6. Endplate Overhang

- o. Any filler panels that are not used should be kept for future use. Filler panels must be installed in all unused card slots for correct air circulation.

Adding Acquisition Cards

Use this procedure if you are adding acquisition cards to a system that already has an HP 16530A/31A Oscilloscope Module installed. Make note of the "Installation Considerations" on page A-2 before starting.

- a. Turn instrument power switch off, unplug power cord and disconnect all input BNCs.
- b. Starting from the top, loosen thumb screws on filler panel(s) and card(s).
- c. Starting from the top, begin pulling all cards out half way. See figure A-7.

CAUTION

Some modules are hooked together by intercard connecting cables.

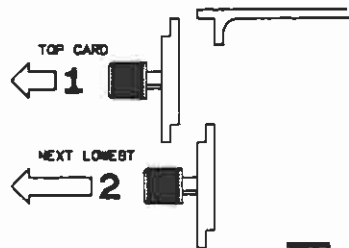

Figure A-7. Endplate Overhang

- d. Pull all cards in oscilloscope module completely out and disconnect all cable(s) from acquisition card(s).
- e. Push all other cards into card cage, but not completely in. This will get them out of the way for oscilloscope module installation.
- f. Use figure A-8 to plan the card configuration and cable connection.

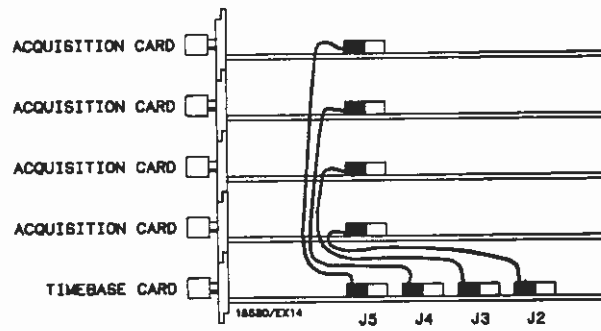

Figure A-8. Card and Cable Configuration

- g. Install one cable per acquisition card in the correct timebase card connector, making sure that you install the correct end. See figure A-9.

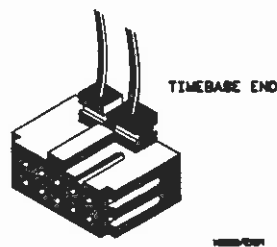

Figure A-9. Cable End

- h. Lay cable(s) flat and pointing out to rear of card. See figure A-10.

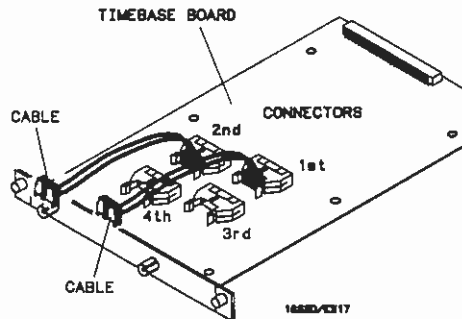

Figure A-10. Cable Position

- i. Slide timebase card approximately half way into lowest slot being used for the scope module.
- j. Slide acquisition card in half way, feeding cable(s) up through square hole in acquisition card.
- k. Plug in other end of cable to connector on acquisition card.
- l. Slide next acquisition card in half way, feeding cable(s) up through square hole in acquisition card.
- m. Plug in other end of next cable to connector on acquisition card.
- n. If you have additional acquisition cards, repeat steps i through n until all cards are in half way and all cables are connected.
- o. Firmly seat bottom card in backplane connector. **Keep applying pressure to the center of card endplate while tightening thumb screws finger tight.**

- p. Repeat for all cards and filler panels in a bottom to top order. See figure A-11.

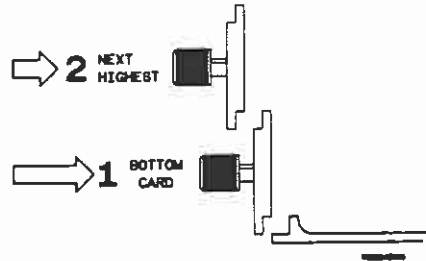

Figure A-11. Endplate Overhang

- q. Any filler panels that are not used should be kept for future use. Filler panels **must** be installed in all unused card slots for correct air circulation.

Operating Environment

The operating environment is listed in "General Characteristics" in Appendix B. Note should be made of the non-condensing humidity limitation. Condensation within the instrument can cause poor operation or malfunction. Protection should be provided against internal condensation.

The HP 16530A/31A will operate at all specifications within the temperature and humidity range given in Appendix B. However, reliability is enhanced by operating the instrument within the following ranges:

Temperature: +20 to +35° C (+68 to +95° F)

Humidity: 20% to 80% non-condensing

Storage

The module may be stored or shipped in environments within the following limits:

Temperature: -40° C to +75° C

Humidity: Up to 90% at 65° C

Altitude: Up to 15,300 meters (50,000 Feet)

The module should also be protected from temperature extremes which cause condensation on the module.

Packaging

The following general instructions should be used for repacking the module with commercially available materials.

- Wrap module in anti-static plastic.
 - Use a strong shipping container. A double-wall carton made of 350 lb. test material is adequate.
 - Use a layer of shock-absorbing material 70 to 100 mm (3 to 4 inch) thick around all sides of the module to provide firm cushioning and prevent movement inside the container.
 - Seal shipping container securely.
 - Mark shipping container FRAGILE to ensure careful handling.
 - In any correspondence, refer to module by model number and board number.
-

Tagging for Service

If the module is to be shipped to a Hewlett-Packard office for service or repair, attach a tag showing owner (with address), complete board number, and a description of the service required.

B

Specifications and Characteristics

Specifications

Vertical (at BNC)	Bandwidth (-3 dB)	dc to 100 MHz (dc-coupled)		
	Range	40 mV to 18 V full scale (adjustable with 2-digit resolution)		
	DC Gain Accuracy	±3% of full scale (valid within ± 10° C of auto-calibration temperature)		
	Analog-to-Digital Conversion (ADC) Resolution	±1.8% of full scale (8 bits)		
	DC Offset Accuracy	±1% of offset ±3.2% of full scale (valid within ±10° C of auto-calibration temperature)		
	DC Offset Range/Resolution	Vertical Range	Offset Range	Offset Resolution
		<800 mV	±800 mV	1 mV
		≥800 mV	±18 mV	20 mV
	Voltage Measurement Accuracy (DC)			
	Single Cursor (X or O)	= Gain accuracy + ADC resolution + offset accuracy		
	Dual Cursor (X to O measurements on the same waveform)	= Gain accuracy + 2 (ADC resolution)		

Horizontal	Range	50 ns to 100 s full scale, adjustable with 3-digit resolution
	Time Interval Measurement Accuracy (dual channel for deskewed channels with equal rise time and fall times)	± 0.75 ns $\pm 0.2\%$ of timebase range $\pm 0.02\%$ of reading (2.5 ns sample period)
		\pm sample period $\pm 0.2\%$ of timebase range $\pm 0.02\%$ of reading (≥ 5 ns sample period)
	Delay (Time Offset)	
	Pre-trigger Range	4096 x sample period
	Post-trigger Range	500 screen diameters
	Resolution	Fine adjustment to 0.2% of screen diameter

Trigger	Sources	Any internal channel, or external trigger input
	Internal Trigger Sensitivity	$\leq 12\%$ of full scale (dc to 100 MHz)
	Range	Within display window (full scale and offset)
	Resolution	1% of full scale
	External Trigger Input (rear panel input BNC)	
	Sensitivity	≤ 20 mV (dc to 100 MHz)
	Range	± 2 V
	Resolution	2 mV
	Input coupling	dc

Characteristics

Vertical	Transition Time (10% to 90%)	≤ 3.5 ns
	Input Coupling	dc
	Input RC	1 M Ω $\pm 2\%$ or 50 Ω $\pm 3\%$, shunted by approximately 13 pF
	Maximum Safe Input Voltage	1 M Ω Input, ± 40 V (dc + peak ac) 50 Ω Input, ± 5 V (dc + peak ac)
	Probe Factors	Any integer ratio from 1:1 to 1:1000, to scale the oscilloscope to represent voltages seen at the probe tip

Timebase	Deskewing	Skew between channels can be nulled out to compensate for probe/cable lengths.
-----------------	------------------	--

Trigger	External Trigger Input (Rear panel input BNC)	
	Input RC	1 M Ω $\pm 2\%$ or 50 Ω $\pm 3\%$, shunted by approximately 12 pF
	Maximum Safe Input Voltage	1 M Ω Input ± 40 V (dc + peak ac) 50 Ω Input ± 5 V (dc + peak ac)
	Trigger Modes	
	Immediate	Allows oscilloscope to be triggered by port-In, or another HP 16500-series measurement module.
Edge	Triggers on rising or falling edge of any internal channel or external trigger, count adjustable from 1 to 32,000.	
Pattern	Triggers on entering or exiting a specified pattern of all internal channels and external trigger, count adjustable from 1 to 32,000	

Trigger (cont)	Auto-Trigger	If enabled, the timebase will self-trigger if the trigger rate is below 40 Hz.
	Events Delay	The trigger can be set to occur on the nth edge or pattern, as specified by the user. The number of events (n) can be set from 1 to 32,000 events.
	Outputs/Rear-panel BNC	HP 16530A output BNC provides a probe compensation source - 1 kHz square wave, switching between -0.4 V and -0.8 V, with 50 Ω output resistance.

Digitizer	Resolution	6 bits (1 part in 64)
	Digitizing Rate	Up to 400 megasamples/second
	Digitizing Technique	Real-time digitizing; each 4k record is acquired on a single acquisition
	Acquisition Memory Size	4096 samples per channel

Waveform Display	Display Formats	Waveforms can be displayed in an overlapping and/or non-overlapping format.
	Display Resolution	500 points horizontally
	Display Modes	
	Single	New acquisitions replace old acquisitions on screen.
	Accumulate	New acquisitions are added to the screen and displayed with older acquisitions until screen is erased.
	Average	New acquisitions are averaged with older acquisitions with updated waveform displayed until erased.
	Overlay	Up to 8 acquired waveforms can be overlaid in the same display area.
	Connect-the-dots	Provides a display of the sample points connected by straight lines.

Waveform Display (cont)	Waveform Reconstruction	When there is insufficient data to fill every horizontal location, a post acquisition reconstruction filter fills in the missing locations.								
	Waveform Math	Display capability of A-B and A+B functions is provided.								
Measurement Aids	Markers	Two vertical markers are provided for measurements of time and voltage. Capabilities are: measure voltage of X and O on each analog waveform; measure time from X to trigger, O to trigger, and X to O; automatic marker placement by specifying percentage of edge, edge number, and rising or falling edge type; run until X to O > than, < than, in range, and not in range provides selective event search; X to O statistics (mean, max, and min) provide analysis of time interval deviation.								
	Automatic Measurements	The following pulse parameter measurements can be performed automatically: <table border="0" data-bbox="790 1160 1236 1254"> <tr> <td>Frequency</td> <td>Rise time</td> <td>Overshoot</td> </tr> <tr> <td>Period</td> <td>Fall time</td> <td>+ pulse width</td> </tr> <tr> <td>V p-p</td> <td>Preshoot</td> <td>- pulse width</td> </tr> </table>	Frequency	Rise time	Overshoot	Period	Fall time	+ pulse width	V p-p	Preshoot
Frequency	Rise time	Overshoot								
Period	Fall time	+ pulse width								
V p-p	Preshoot	- pulse width								
Setup Aids	Autoscale	Auto sets the vertical and horizontal ranges, offset, and trigger level to display the input signals. Requires an amplitude above 10 mV peak, and a frequency between 50 Hz and 100 MHz.								
	Presets	Scales the vertical range, offset, and trigger level to predetermined values for displaying ECL or TTL waveforms.								

General Characteristics

Operating Environment	Temperature	Instrument, 0° to 55° C (+32° to 131° F). Probes and cables, 0° to 65° C (+32° to 149° F).
	Humidity	Instrument, up to 95% relative humidity at +40° C (+104° F). Recommended disc media, 8% to 80% relative humidity at +40° C (+104° F).
	Altitude	To 4600 m (15 000 ft).
	Vibration	
	Operation	Random vibration 5-500 Hz, 10 minutes per axis, ~0.3 g (rms).
Non-operating	Random vibration 5-500 Hz, 10 minutes per axis, ~2.41 g (rms); and swept sine resonant search, 5-500 Hz, 0.75 g (0-peak), 5 minute resonant dwell @ 4 resonances per axis.	

C

Automatic Measurement Algorithms

Introduction

One of the HP 16530A/16531A's primary features is its ability to make parametric measurements on displayed waveforms. This chapter provides details on how automatic measurements are performed and some tips on how to improve automatic measurement results.

Measurement Setup

Measurements typically should be made at the fastest possible sweep speed to obtain the most measurement accuracy possible. For any measurement to be made, the portion of the waveform required for that measurement must be displayed on the oscilloscope. That is:

- at least one complete cycle must be displayed for period or frequency measurements.
- the entire pulse must be displayed for pulse width measurements.
- the leading (rising) edge of the waveform must be displayed for risetime measurements.
- the trailing (falling) edge of the waveform must be displayed for falltime measurements.

Making Measurements

If more than one waveform, edge, or pulse is displayed, the measurements are made on the first (leftmost) portion of the displayed waveform that can be used.

When any of the defined measurements are requested, the oscilloscope first determines the top (100%) and base (0%) voltages of the waveform. From this information, it can determine the other important voltage values (10% voltage, 90% voltage, and 50% voltage) required to make the measurements. The 10% and 90% voltage values are used in the risetime and falltime measurements. The 50% voltage value is used for measuring frequency, period, pulse width, and duty cycle.

Top and Base Voltages

All measurements except V_{p-p} are calculated using the V_{top} (100% voltage) and V_{base} (0% voltage) levels of the displayed waveform. The V_{top} and V_{base} levels are determined from an occurrence density histogram of the data points displayed on screen.

The digitizing oscilloscope displays 6-bit vertical voltage resolution. This means the vertical display is divided up into 2^6 voltage levels. Each of these 64 levels is called a quantization level. Each waveform has 500 data points displayed horizontally on screen. Each of these 500 points has one quantization level assigned to it. The histogram is calculated by adding the number of occurrences of each quantization level of the 500 displayed points on the displayed waveform.

The quantization level with the greatest number of occurrences in the top half of the waveform corresponds to the V_{top} level. The quantization level with the greatest number of occurrences in the bottom half of the waveform corresponds to the V_{base} level.

If V_{top} and V_{base} do not contain at least 5% of the 500 data points displayed on screen, V_{top} defaults to the maximum voltage ($V_{maximum}$) and V_{base} defaults to the minimum voltage ($V_{minimum}$) found on the display. An example of this case would be measurements made on sine or triangle waves.

From this information the instrument can determine the 10, 50, and 90% points, which are used in most automatic measurements. The V_{top} or V_{base} of the waveform is not necessarily the maximum or minimum voltage present on the waveform. If a pulse has a slight amount of overshoot, it would be wrong to select the highest peak of the waveform as the top since the waveform normally rests below the perturbation.

Measurement Algorithms

The following is a condensed explanation of the automatic measurements discussed in chapter 11.

Frequency (Freq) The frequency of the first complete cycle displayed is measured using the 50% levels.

If the first edge on the display is rising then

$$\text{Freq} = 1 / (t_{\text{rising edge 2}} - t_{\text{rising edge 1}})$$

If the first edge on the display is falling then

$$\text{Freq} = 1 / (t_{\text{falling edge 2}} - t_{\text{falling edge 1}})$$

Period The period is measured at the 50% voltage level of the waveform.

If the first edge on the display is rising then

$$\text{Period} = t_{\text{rising edge 2}} - t_{\text{rising edge 1}}$$

If the first edge on the display is falling then

$$\text{Period} = t_{\text{falling edge 2}} - t_{\text{falling edge 1}}$$

Peak-to-Peak Voltage (Vp_p) The maximum and minimum voltages for the selected source are measured.

$$V_{p_p} = V_{\text{maximum}} - V_{\text{minimum}}$$

where V_{maximum} and V_{minimum} are the maximum and minimum voltages present on the selected source.

Positive Pulse width (+Width) Pulse width is measured at the 50% voltage level.
If the first edge on the display is rising then

$$+Width = t_{falling\ edge\ 1} - t_{rising\ edge\ 1}$$

If the first edge on the display is falling then

$$+Width = t_{falling\ edge\ 2} - t_{rising\ edge\ 1}$$

Negative Pulse width (-Width) Negative pulse width is the width of the first negative pulse on screen using the 50% levels.

If the first edge on the display is rising then

$$-Width = t_{rising\ edge\ 2} - t_{falling\ edge\ 1}$$

If the first edge on the display is falling then

$$-Width = t_{rising\ edge\ 1} - t_{falling\ edge\ 1}$$

Risetime The risetime of the first displayed rising edge is measured. To obtain the best possible measurement accuracy, set the sweep speed as fast as possible while leaving the leading edge of the waveform on the display. The risetime is determined by measuring time at the 10% and 90% voltage points on the rising edge.

$$Risetime = t_{90\%} - t_{10\%}$$

Falltime Falltime is measured between the 10% and 90% points of the falling edge. To obtain the best possible measurement accuracy, set the sweep speed as fast as possible while leaving the falling edge of the waveform on the display.

$$Falltime = t_{10\%} - t_{90\%}$$

Preshoot and Overshoot Preshoot and Overshoot measure the perturbation on a waveform above or below the top and base voltages (see "Top and Base Voltages" section earlier in this appendix). These measurements use all data displayed on screen, therefore it is very important that only the data of interest be displayed. If you want to measure preshoot and overshoot on one edge of a waveform, then only display that edge. If you want to measure the maximum preshoot and overshoot on a waveform, then display several cycles of the waveform.

Preshoot is a perturbation before a rising or a falling edge and is measured as a percentage of the top-base voltage.

Overshoot is a perturbation after a rising or a falling edge and is measured as a percentage of the top-base voltage

If the measured edge is rising then

$$\text{Preshoot} = \left[\frac{V_{\text{base}} - V_{\text{minimum}}}{V_{\text{top-base}}} \right] \times 100$$

$$\text{Overshoot} = \left[\frac{V_{\text{maximum}} - V_{\text{top}}}{V_{\text{top-base}}} \right] \times 100$$

If the measured edge is falling then

$$\text{Preshoot} = \left[\frac{V_{\text{maximum}} - V_{\text{top}}}{V_{\text{top-base}}} \right] \times 100$$

$$\text{Overshoot} = \left[\frac{V_{\text{base}} - V_{\text{minimum}}}{V_{\text{top-base}}} \right] \times 100$$

Index

This index covers the *HP 16530A/16531A Reference Manual*. Sequences of pages are represented with a slash (for example, 6-9/6-17).

A

- at Level field, 9-10
- A+B, 12-13
- A-B, 12-13
- Accessories, 1-2
- Accumulate mode (Display), 10-5
- Acquisition memory, 5-3,5-6
- Action field, 12-5,12-7
- Adding acquisition cards, A-7
- Adjustment procedures, 16-1
- Algorithms, C-1
- Arming, 6-5
- Attenuation factor, 4-6
- Auto field (markers), 9-8
- Auto-Marker exercise, 9-15
- Auto-Measure menu map 11-1
- Auto-Measure menu, 11-1,11-4
- Auto-Trig field, 6-9,6-15
- Auto-sweep, 7-4
- Auto-trigger, 6-9,7-4
- Autoload field, 13-8
- Autoloading a configuration, 13-8
- Automatic marker measurements, 9-8
- Automatic measurement algorithms, C-1
- Autoscale, 7-1
- Average #, 10-4
- Average mode (Display), 10-4
- Average time interval, 9-11

B

- BNC adapter, 1-2,3-2
- BNC cables, 3-2

- Balance Adjust field, 16-3
- Bandwidth, 8-1
- Base voltage, 11-2,C-2

C

- Cables, 3-1
- Cal Choice field, 16-3
- Calibration factors, 16-1
- Calibration integrity, 16-4
- Calibration menu map, 16-2
- Calibration menu, 16-1,16-3
- Calibration prerequisites, 16-4
- Cancel field (Autoscale), 7-2
- Cancel field (Print), 14-2
- Cancel field (Repetitive run mode), 8-3
- Cancel field (Single run mode), 8-2
- Chan+Chan, 12-13
- Chan-Chan, 12-13
- Channel Input field, 4-3
- Channel Mode field, 12-10
- Channel label field, 9-6,12-5
- Channel menu map, 4-2
- Channel menu, 4-1
- Channel mode, 12-13
- Channel offset, 4-5
- Channel-to-channel skew, 16-8
- Characteristics, B-3,B-6
- Compensation signal, 3-1
- Configuration files, 13-1
- Connect-dots, 10-1,10-6
- Count field (trigger), 6-10,6-16

D

Data entry fields, 206
Data points, 11-2,C-2
Delay calibration, 16-7
Delay field, 5-5
Delay time, 5-5,6-4
Delay-by-events, 6-10
Delete field, 12-9
Deleting a channel, 12-9
Digitizing rate, 5-8
Disc drive, 13-6,13-8
Disc menu, 13-1,13-6
Display menu map, 10-1
Display menu, 10-1
Display mode, 10-2
Don't care, 6-13
Dual-timebase installation, A-1
Dual-timebase, 6-5,13-3, 15-1, A-1

E

ECL preset, 4-8
Edge occurrences, 9-10
Edge trigger mode, 6-6
Edge trigger, 6-3
Events counter, 6-9
Events triggering, 6-10
External trigger, 4-3,4-7,6-6

F

Falltime measurement, 11-1,11-7,C-4
Features, 1-1
file description field, 13-4
Floppy disc, 13-1,13-8,16-1,16-3
Free-run mode, 6-5
Frequency measurement, 11-1,11-10,C-3
Front disc menu, 13-1,13-6,13-8

G

General characteristics, B-6
Greater Than field, 9-13
Group Run, 6-5,15-3

H

HP-IB, 14-1
Histogram, 11-2,C-2
Horizontal axis, 5-2

I

Immediate trigger mode, 6-5,15-7
Impedance field, 4-7
In Range field, 9-14
Independent field, 6-5
Infinite persistence, 10-5
Input field (Auto-Measure), 11-5
Input field (Channel), 4-3
Input impedance, 4-7
Input labels, 15-8
Input port, 6-5
Input source, 4-3
Input, 6-6
Insert field, 12-7
Inserting a channel, 12-7
Installing acquisition cards, A-7
Installing boards, A-1
Intermodule menu, 6-5,15-2,15-4

K

Keypad, 2-6
Knob, 2-1,2-6

L

Label, 12-5,12-7,12-9
Less Than field, 9-12
Level field (Trigger), 6-7
Loading a configuration, 13-6

M

Manual field, 9-9
Marker measurements (automatic), 9-8
Marker measurements (manual), 9-4
Marker measurements, 9-1
Marker voltage values, 9-7
Markers menu map, 9-2
Max X-O field, 9-11
Maximum time interval, 9-11
Maximum voltage, 9-8,11-2,11-12,C-2,C-5
Mean X-O field, 9-11
Mean time interval, 9-11
Measurement algorithms, C-1
Measurement data, 13-1
Measurement field, 11-5
Memory depth, 5-7
Menu field Index, 1-3
Menu maps, 1-4/1-9
Min X-O field, 9-11
Mini-probes, 1-2
Minimum time interval, 9-11
Minimum voltage, 9-8,11-2,11-12,C-2,C-5
Mode field (Display), 10-2
Mode field (Trigger), 6-3
Module field, 2-4
Module installation, A-2
Module menus, 2-3
Mouse, 2-1,2-7

N

Negative slope (markers), 9-10
Negative slope, 6-8
Negative time, 9-5,9-13,15-5

Negative width measurement, 11-11,C-4
Normal mode (Display), 10-3
Not In Range field, 9-14
Number of averages, 10-4

O

O marker, 9-4
Occur field, 9-10
Occurrence count, 9-10
Offset field, 4-5
Offset, 4-9
Operating Environment, A-10
Operating characteristics, B-3
Operating disc, 16-1
Oscilloscope configuration, 13-1
Overlay channel mode, 12-11
Overlay field, 12-11
Overshoot measurement, 11-1,11-12,C-5
Overshoot, 9-8

P

Packaging, A-11
Pattern trigger exercise, 6-17
Pattern trigger mode, 6-11
Peak-to-peak voltage
 measurement, 11-1,11-9,C-3
Peak-to-peak voltage, 9-8
Percentage level, 9-10
Percentage points, 11-2,C-2
Performance tests, 16-1
Period measurement, 11-1,11-10,C-3
Positive pulse width measurement, 11-1
Positive slope (markers), 9-10
Positive slope, 6-8,9-7,9-13,15-5
Positive width measurement, 11-11,C-4
Post-trigger delay, 5-5
Post-trigger range, 5-7
Pre-trigger delay, 5-5
Pre-trigger range, 5-7
Preset field, 4-8

Preshoot measurement, 11-1,11-12,C-5
Preshoot, 9-8
Print Screen field, 14-2
Print field, 14-1
Printer configuration, 14-1
Probe attenuation factor, 4-6
Probe field, 4-6
Probes, 1-2,3-1,3-2

Q

Quantization level, 11-2,C-2

R

RS-232C, 14-1
Real-time digitizing, 8-1
Rear disc menu, 13-1,13-6,13-8
Recalling configurations, 13-1
Reconstruction filter, 5-4
Repair, A-11
Repetitive mode, 10-5
Repetitive mode, 8-1,8-3,9-11,9-12,10-5
Replace field, 12-5
Replacing a channel, 12-5
Returning for service, A-11
Risetime measurement, 11-1,11-6,C-4
Run Until Time field, 9-12
Run field, 4-4,4-6,8-1,8-3

S

Sample dots, 10-6
Sample period, 5-7,5-8
Sample points, 5-3
Sample rate, 5-5/5-8
Saving configurations, 13-1
Scrolling, 5-4,5-6
s/Div field, 5-1,5-2
Service, A-11
Set on field, 9-9
Set to Default field, 16-3

Shipping, A-11
Single channel mode, 12-10
Single field (channel mode), 12-11
Single mode, 10-5
Single mode, 8-1,8-2
Single-shot, 5-3,5-6,8-2
Skew (Intermodule), 15-5
Skew (channel calibration), 16-8
Slope field (markers),9-10
Slope field, 6-8
Slot, 4-3
Source field (Trigger), 6-6
Specifications, B-1
Statistics field, 9-11
Status field, 15-4
Stop condition, 9-12
Stop field, 8-1,8-3
Storage, A-11
Storing a configuration, 13-1
Sweep speed, 5-1,5-2,5-7

T

TTL preset, 4-8
Tagging for Service, A-11
Tick marks, 4-4,4-5,5-2
Time correlation bars, 15-4,15-11
Time measurements, 9-1,11-1
Time offset, 5-5
Time scale, 5-2
Timebase, 5-1
to file field, 13-3
Top voltage, 11-2,C-1,C-2
Top-base voltage, 9-8,9-10,11-2,C-2
Touch screen, 2-2
Trig to O field, 9-5
Trig to X field, 9-5
Trigger count, 6-10
Trigger events counter, 6-9
Trigger level calibration, 16-6
Trigger level, 4-9,6-7
Trigger marker, 6-4,6-7

Trigger menu map, 6-2
Trigger menu, 6-1
Trigger mode, 6-3,15-7
Trigger modes, 6-1
Trigger point, 5-5,5-6,6-4,6-15
Trigger qualfler, 6-10,6-16
Trigger slope, 6-8
Trigger source, 6-6,7-3

U

User defined levels, 4-9
User interface, 2-1

V

V/Div field, 4-4,4-9
Vbase, 11-2,C-2,C-5
Vertical callbration, 16-5
Vertical positlon, 4-5
Vertical sensitivity, 4-4
Vertical voltage resolution, 11-2,C-2
Vmaximum, 11-2,11-12,C-2,C-5
Vminimum, 11-2,11-12,C-2,C-5
Voltage levels, 11-2,C-2

Voltage measurements, 9-1,11-1
Voltage values (markers), 9-7
Vp_p measurement, 11-1, 11-9,C-3
Vtop, 11-2,C-2,C-5

W

-Width measurement, 11-1,11-11,C-4
+Width measurement, 11-1,11-11,C-4
Waveform Selection menu map, 12-1
Waveform Selection pop-up, 12-1
Waveform math, 12-10,12-13
Waveform record, 5-3,5-6,8-1
When Entered field, 6-14
When Exited field, 6-14

X

X marker, 9-4
X to O field, 9-6

Z

Zoom, 5-3,5-6
Zoom, 5-6

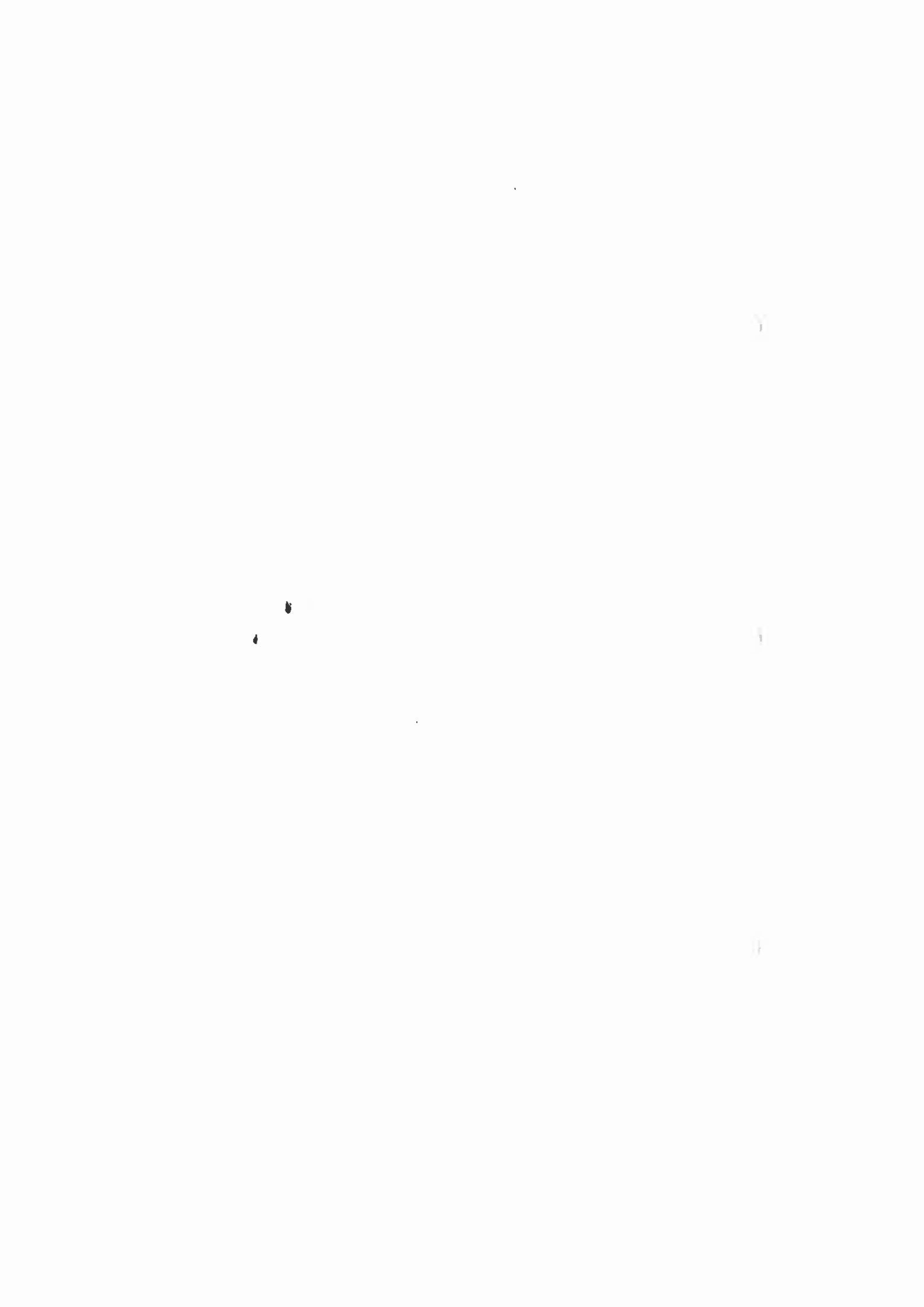

DIRECTORY

Worldwide Sales and Support

Hewlett-Packard products are sold and supported worldwide through HP offices.

- To contact one of the more than 240 HP Sales and Service Offices worldwide, check your telephone directory or contact one of the major HP offices listed.

- | | | |
|---|--|---|
| Argentina
■ Martinez
Phone: 798-6086 | Mississauga, Ontario
Phone: 416/678-9430 | Japan
Yokogawa-Hewlett
Packard |
| Australia
North Ryde, N.S.W.
Phone: 02/887-1611 | Denmark
■ Birkerød
Phone: 2/81-66-40 | Osaka
Phone: 6/304-6021 |
| Blackburn, Victoria
Phone: 03/890-6351 | Finland
■ Espoo
Phone: 90/455-0211 | Sagamihara
Phone: 427/59-1311 |
| Austria
■ Vienna
Phone: 222/3516210 | Jyvaskyla
Phone: 41/216318 | Tokyo
Phone: 3/331-6111 |
| Belgium
■ Brussels
Phone: 02/762-3200 | Oulu
Phone: 81/338785 | Malaysia
■ Kuala Lumpur
Phone: 03/943-022 |
| Brazil
■ Alphaville, Barueri
Phone: 011/421-1311 | France
■ Les Ulis
Phone: 1/9077825 | Mexico
■ Xochimilco, Mexico City
Phone: 905/676-8895 |
| Canada
■ Edmonton, Alberta
Phone: 403/452-3670 | Hong Kong
Wanchai
Phone: 5/832-3211 | The Netherlands
■ Amstelveen
Phone: 020/472021 |
| Richmond, British
Columbia
Phone: 604/270-2277 | Italy
Cernusco Sul Naviglio
Phone: 2/903691 | New Zealand
Pakuranga
Phone: 9/68-7159 |

-
- Full Field Repair Center capabilities.

- | | | |
|--|---|--|
| <p>Norway</p> <ul style="list-style-type: none"> ■ Oesteraas
Phone: 2/17-11-80 | <p>Switzerland</p> <ul style="list-style-type: none"> ■ Widen
Phone: 57/31-21-11 | <ul style="list-style-type: none"> ■ Rockville, Maryland
Phone: 301/948-6370 |
| <p>Puerto Rico</p> <ul style="list-style-type: none"> Carolina
Phone: 809/762-725 | <p>Taiwan</p> <ul style="list-style-type: none"> ■ Taipei
Phone: 2/712-0404 | <ul style="list-style-type: none"> ■ Andover, Massachusetts
Phone: 617/861-8960 |
| <p>Saudi Arabia</p> <ul style="list-style-type: none"> ■ HP Distributor,
Modern Electronics
Riyadh
Phone: 01/4919715 | <p>United Kingdom</p> <ul style="list-style-type: none"> ■ Altrincham
Phone: 61/928-6422 | <ul style="list-style-type: none"> ■ Novi, Michigan
Phone: 313/349-9200 |
| <p>Singapore</p> <ul style="list-style-type: none"> ■ Singapore
Phone: 631788 | <p>United Kingdom</p> <ul style="list-style-type: none"> ■ Winnerah, Wokingham
Phone: 734/784-774 | <ul style="list-style-type: none"> ■ Paramus, New Jersey
Phone: 201/265-5000 |
| <p>South Africa</p> <ul style="list-style-type: none"> ■ Sandton, Transvaal
Phone: 11/802-511 | <p>United States</p> <ul style="list-style-type: none"> ■ Santa Clara, California
Phone: 408/988-7000 | <ul style="list-style-type: none"> ■ King of Prussia,
Pennsylvania
Phone: 215/265-7000 |
| <p>Spain</p> <ul style="list-style-type: none"> ■ Mirasierra, Madrid
Phone: 91/734-1162 | <ul style="list-style-type: none"> ■ Los Angeles, California
Phone: 213/970-7500 | <ul style="list-style-type: none"> ■ Richardson, Texas
Phone: 214/231-6101 |
| <p>Sweden</p> <ul style="list-style-type: none"> ■ Spanga
Phone: 8/750-2000 | <ul style="list-style-type: none"> ■ Englewood, Colorado
Phone: 303/771-3455 | <ul style="list-style-type: none"> ■ Bellevue, Washington
Phone: 206/643-4000 |
| | <ul style="list-style-type: none"> ■ Atlanta, Georgia
Phone: 404/955-1500 | <p>Venezuela</p> <ul style="list-style-type: none"> ■ Caracas
Phone: 2/239-4133 |
| | <ul style="list-style-type: none"> ■ Rolling Meadows, Illinois
Phone: 312/255-9800 | <p>West Germany</p> <ul style="list-style-type: none"> ■ Boeblingen
Phone: 7031/667750 |

-
- Full field Repair Center capabilities.

Other European Locations

For information on European locations other than those listed, contact:

Hewlett-Packard, S.A.
150, Route du Nant-d'Avril
P.O. Box
1217 Meyrin 2
Geneva, Switzerland

Other International Locations

For information on locations outside the U.S. and Europe that are not listed, contact:

Hewlett-Packard Intercontinental
3495 Deer Creek Road
Palo Alto, CA 94304 U.S.A.