

Ideal for mobile communication applications including base stations and handsets, from the development stage to production and installation

- Frequency range: 9 kHz to 13.5 GHz
- World's highest dynamic range*
Average display noise level: -168 dBm/Hz typ. (@1 GHz, preamplifier on)
1 dB compression point: >+6 dBm (200 MHz to 3.3 GHz, preamplifier off)
Third-order intermodulation distortion (TOI): >+21 dBm (1 GHz to 2 GHz)
- Diverse options for modulation analysis available
W-CDMA (HSDPA), cdma2000 (1xEV-DV)

*: As of January 2005



R3477

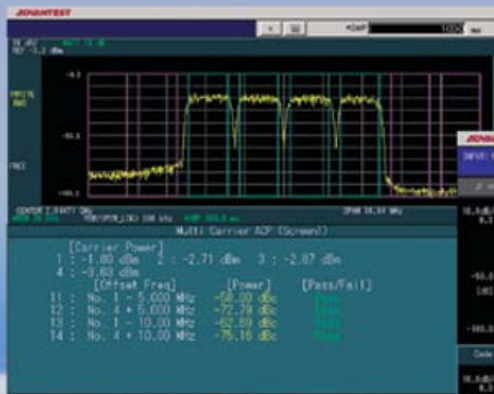

W-CDMA

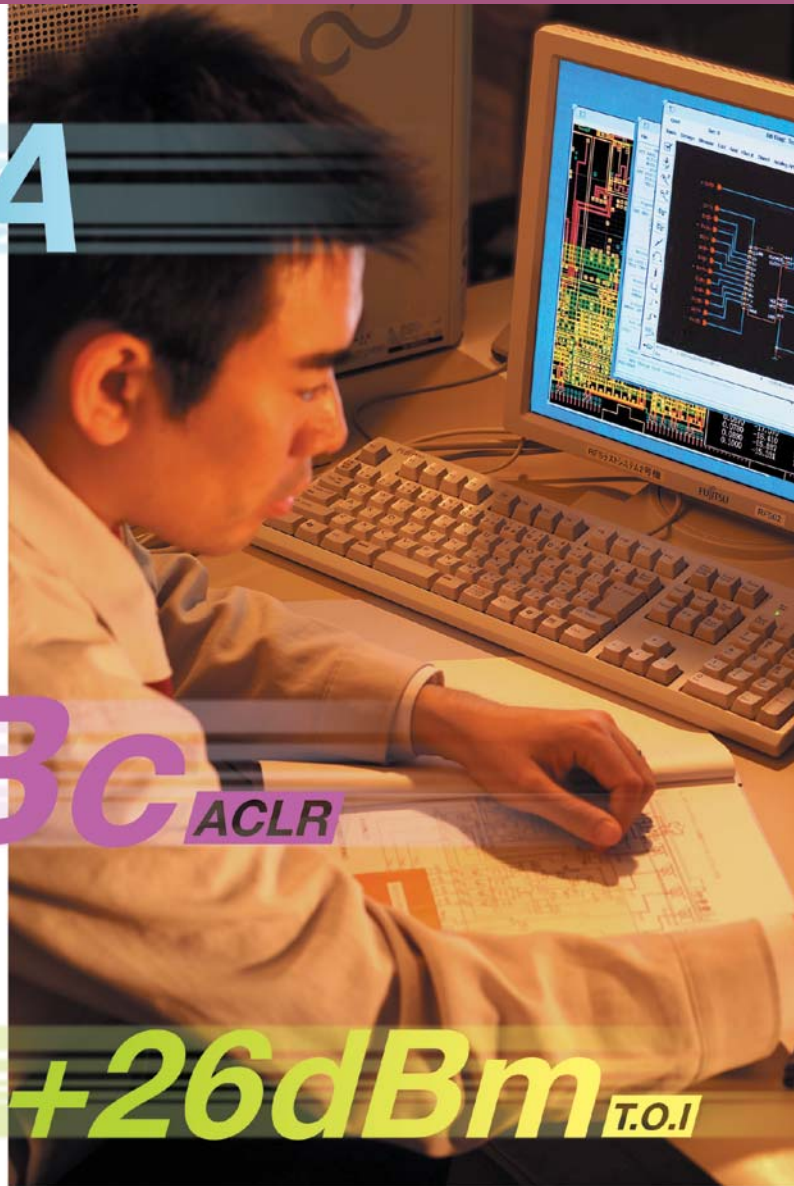

-86dBc ACLR

+26dBm T.O.I

The IMT-2000 is a third-generation mobile telephone system used to implement increased data transfer speeds, improved voice quality, and international roaming service. The IMT-2000 utilizes a broadband RF digital modulation technique for high-speed data transfer, adopts a multicarrier system to accommodate growth in the number of users, and incorporates other new technologies. In an environment for mobile phone systems, measuring instruments must have higher performance and, at the same time, the flexibility required for developing new communication systems and responding to changes in communication specifications.

The R3477 signal analyzer is a high-performance spectrum analyzer that has been developed to meet these requirements. With our proprietary RF technology, the signal analyzer achieves an average display noise level of -158 dBm^{*1} and third-order intermodulation distortion (TOI) of $+26 \text{ dBm}^{*2}$. The wide dynamic range that they can measure is unprecedented. Their noise correction function enables measurement of a wide dynamic range of -86 dBc (representative value), especially useful in measurement of the adjacent channel leakage ratio (ACLR) of 3GPP (W-CDMA). In addition to RF measurement, the R3477 has a broadband modulation analysis function (25 MHz bandwidth) as standard. By adding signal analysis options, each of which is dedicated to a different communication system, the R3477 provides expanded functionality and can be used as a transmitter tester.

*1: Representative value for RBW of 1 Hz, and a frequency of 1 GHz, when the built-in preamplifier is off

*2: Representative value at a range of 2 GHz to 3.3 GHz

- Frequency range
9 kHz to 13.5 GHz
- High-performance spectrum analysis
- Flexibility in digital modulation analysis
3GPP (W-CDMA), 3GPP2 (cdma2000), etc.
- Increased measurement accuracy through digitalization of a substantial number of circuits
- Different types of user interfaces provided
8.4-inch TFT display (touch panel)
Mouse, keyboard, external memory, etc.: USB
Remote control, external control: LAN and GPIB
Monitor output: VGA



cdma2000

-158dBm DANL



Diverse options

OPT.21	High stability frequency standard $\pm 5 \times 10^{-9}$ /day
OPT.22	High stability frequency standard $\pm 3 \times 10^{-10}$ /day, $\pm 2 \times 10^{-8}$ /year
OPT.23	Rubidium frequency standard $\pm 1 \times 10^{-10}$ /month
OPT.50	3GPP modulation analysis software (supporting HSDPA)
OPT.52	cdma2000 modulation analysis software (supporting 1xEV-DV)
OPT.71	6 GHz broadband converter

The modulation analysis bandwidth of 25 MHz is expanded from the standard range of 20 MHz to 3.3 GHz to the range of 20 MHz to 6 GHz.

OPT.79	Tracking generator
---------------	--------------------

*Output amplitude range: -10 dBm to 0 dBm
Frequency range: 100 kHz to 3.3 GHz*

Package options

Several package options are available for the R3477. Any of the following options can be added to the R3477 basic package.

Package No.	Configuration
1	R3477 + 50 Suitable for RF transmission characteristics evaluation and modulation analysis testing of 3GPP (W-CDMA) systems
2	R3477 + 52 Suitable for RF transmission characteristics evaluation and modulation analysis testing of 3GPP2 (cdma2000) systems

World's Widest Dynamic Range

Our proprietary technologies help to realize the world's widest dynamic range of measurement*. Thus, spurious measurement conforming to category B (measurement based on the 3GPP standard) is now easily performed using only the main unit. In measurement of the 800 MHz band, harmonic distortion limited previous measuring instruments in their measured dynamic range. The harmonic distortion dynamic range of 90 dB achieved by the R3477 is due to the new input filter function developed by ADVANTEST (patent pending).

- Average display noise level:
 - 156 dBm/Hz typ. (@2 GHz, preamplifier off)
 - 168 dBm/Hz typ. (@1 GHz, preamplifier on)
- TOI: > +21 dBm (1 GHz to 2 GHz)

*: As of January 2005

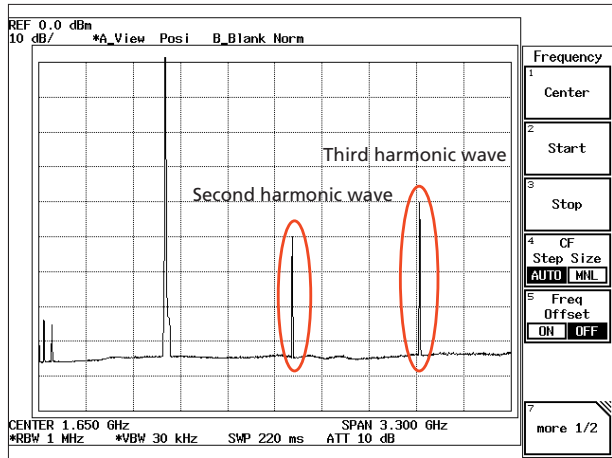

800 MHz input
(previous instruments)

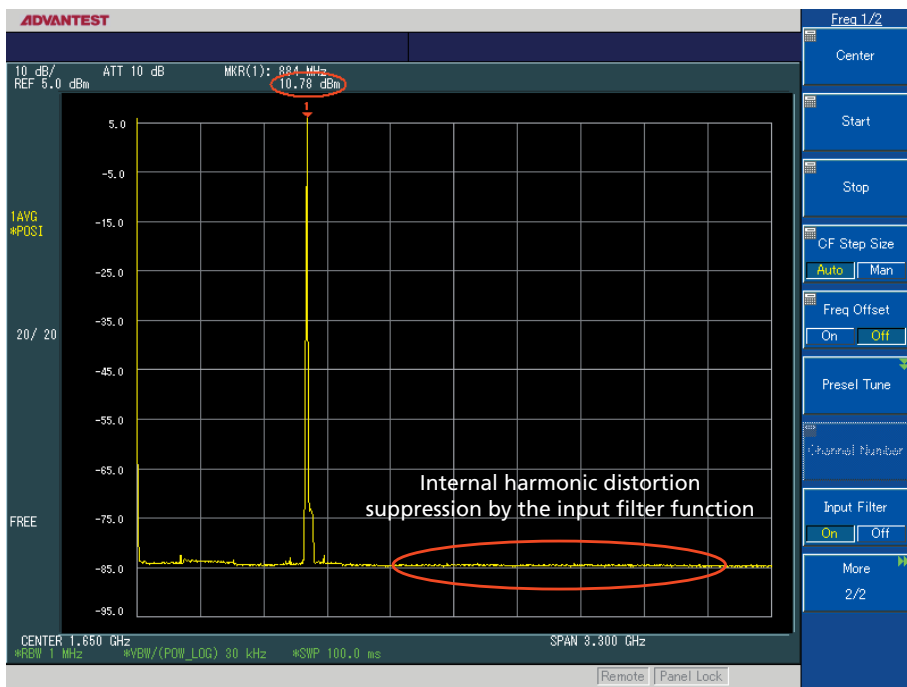

800 MHz input

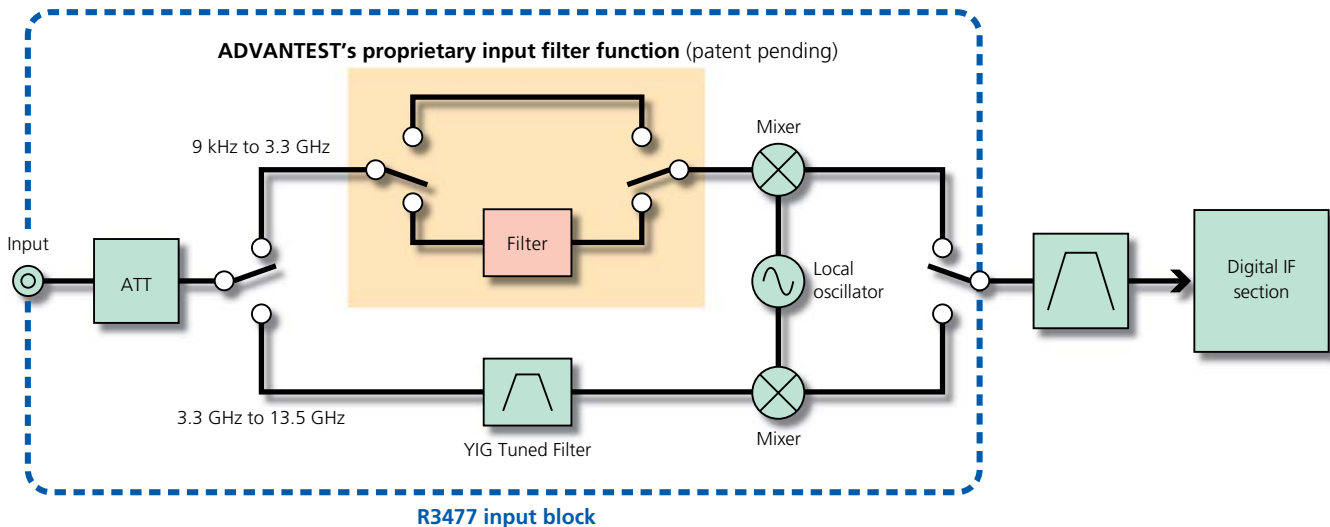

Adjacent channel leakage ratio (ACLR) measurement function

The dynamic range of ACLR measurement depends on the internal noise of the analyzer and two-signal tertiary distortion (spectrum re-growth). The R3477 has a very wide dynamic range as a result of front-end noise reduction and improvement of the tertiary intercept point (+26 dBm typ.).

The displayed measured data is used to calculate carrier wave power, and the integral of this calculated value is calculated with regard to the power of the specified adjacent channel. The ratio of the calculated integral to the carrier wave power

is the ACLR value, which is displayed as an ACLR measurement result.

In addition, measurement using the root Nyquist filter function can be performed, and different digital mobile communication standards, including W-CDMA and cdma2000, are supported. The R3477 is equipped with a proprietary noise correction function and can perform measurement in a wide dynamic range of -86 dBc (representative value), as shown below.

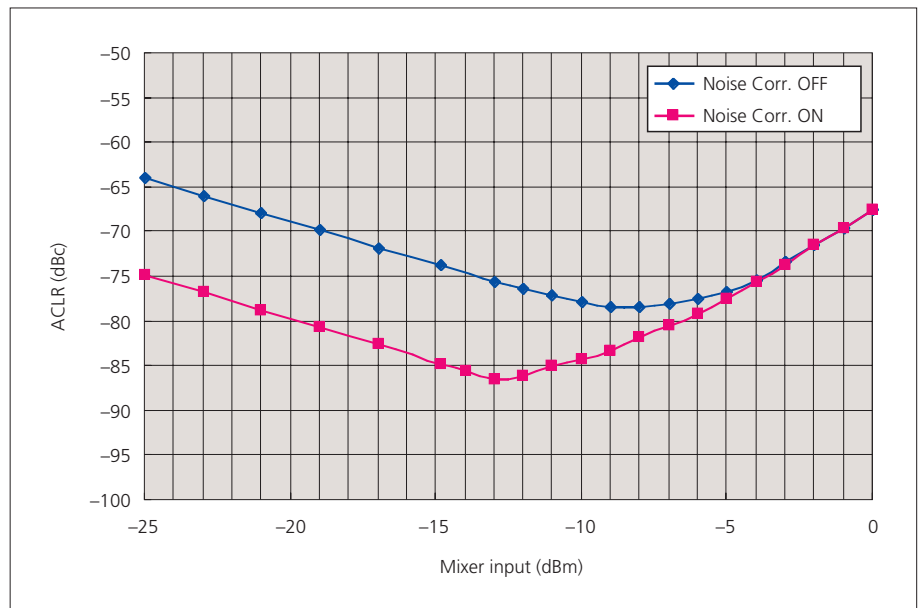

Dynamic range of ACLR measurement at the mixer input level

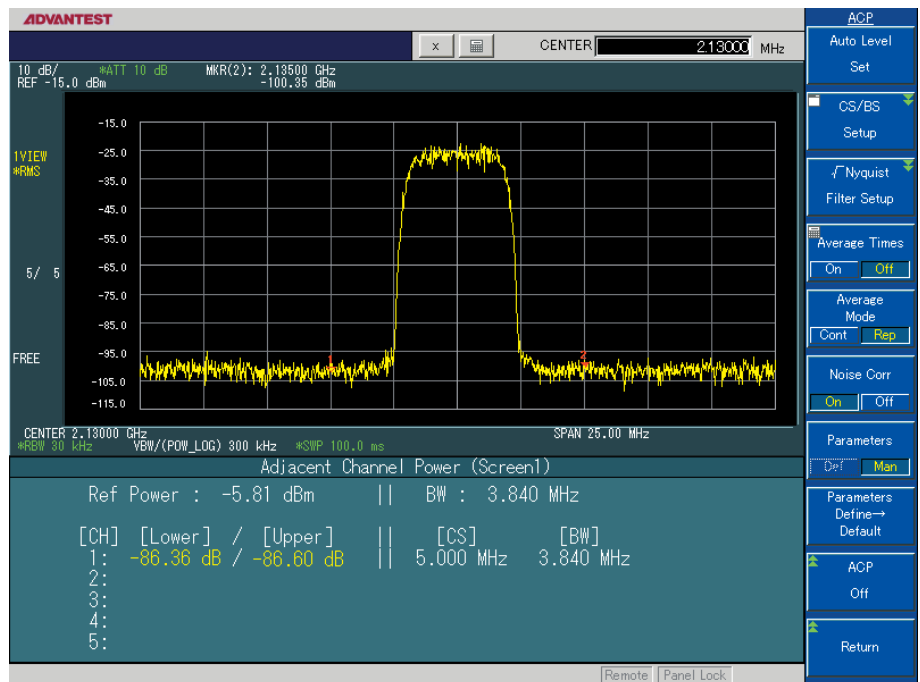

3GPP 1-carrier/ACLR measurement (noise correction enabled)

Level accuracy

The spectrum analyzers incorporate high-performance digital IF technology, making possible high-precision measurement.

- **General level accuracy:**
 $\leq \pm 0.7$ dB (50 MHz to 2.5 GHz; ATT: 10 dB; RBW: 100 kHz)
- **Uncertainty of level display linearity:** $\leq \pm 0.08$ dB
- **The reference level error is 0.**
- **Warm-up: 10 minutes at 0.1 dB typ.**
- **The self-calibration time has been reduced to about one tenth of the conventional value.**

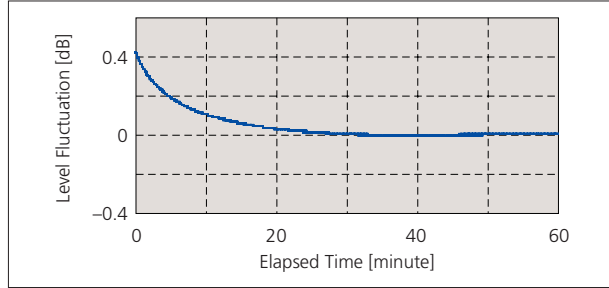

Level stability after power-on

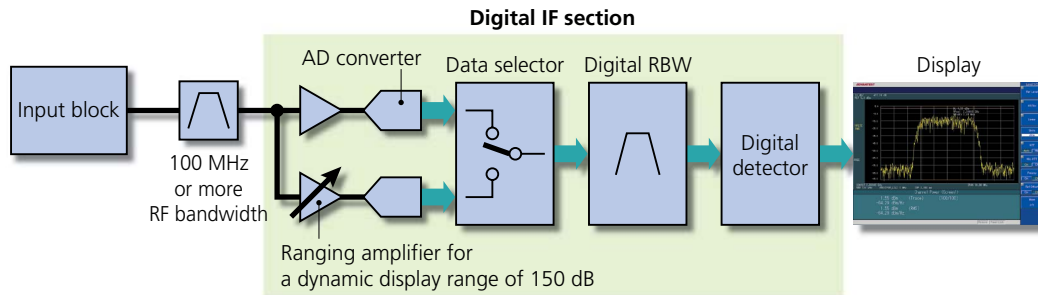

Channel power measurement

RMS power measurement functions

Power measurement functions are provided. These functions are essential for evaluation of W-CDMA (HSDPA), cdma2000, wireless LAN, and other broadband communication systems. The functions are also essential for evaluation of burst signals of GSM, PHS, and other systems that have large amplitude fluctuations.

- **Channel power measurement: RMS measurement of the total power within the band specified in the Measuring window**
- **Average power measurement: Measurement of the average power of the measured screen**

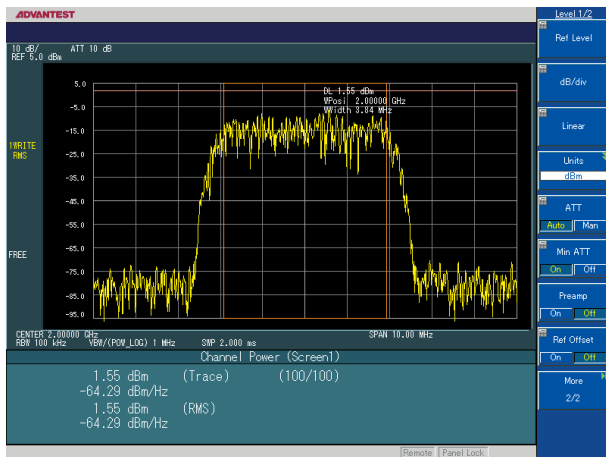

Channel power measurement

T-T, F-F, and F-T measurement

The zoom function uses two windows (windows A and B) to display values. The function can be used for versatile signal analysis, in F-F mode, F-T mode, or T-T mode. F-F mode displays results by different frequency spectra or by different spans, F-T mode displays a zero-span while monitoring spectra (fixed reception function), and T-T mode is useful for partial zoom by time domain.

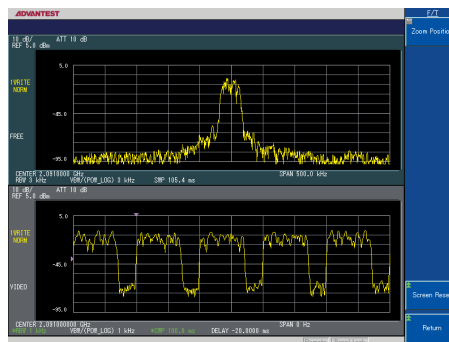

F-T mode display

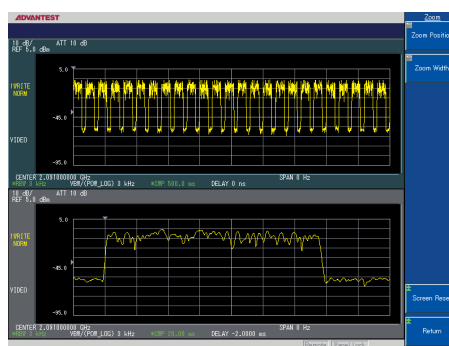

T-T mode display

CCDF measurement function and power display function provided as standard

In CCDF measurement, the CCDF curve of the reference Gaussian noise can be displayed, and the difference between this curve and the Gaussian distribution and peak factors can easily be measured. A CCDF RBW up to 20 MHz can also be measured. Results are acquired by hardware for measurements up to a bandwidth of 10 MHz, which is much faster than calculations performed by software.

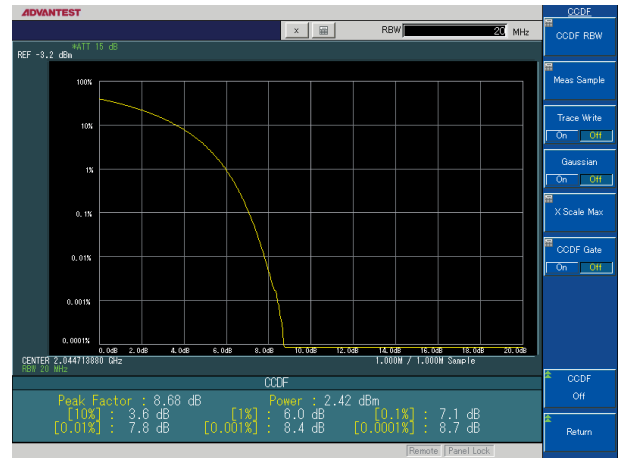

CCDF measurement results/3GPP (HSDPA) four carriers

Gated sweep function

For pulsed RF signals, TDMA signals, and other time-varying signals, most conventional instruments use the MaxHold function for spectrum analysis. In such cases, burst (carrier) signals cannot be separated from spread spectra arising from impulse responses. The R3477 uses the gated sweep function, which enables spectrum analysis unique to each carrier. It can also use the averaging function.



Gated Sweep-OFF

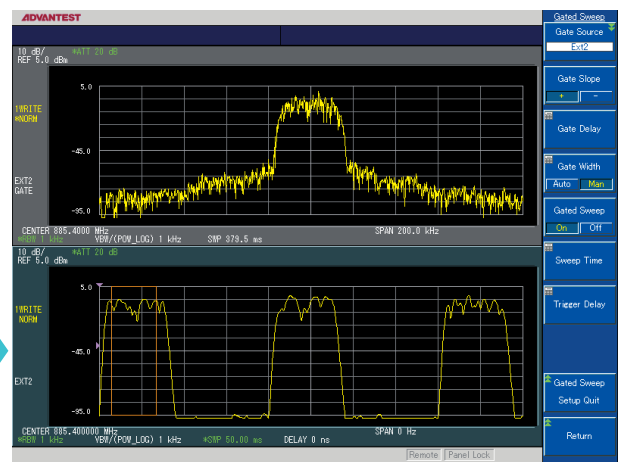

Gated Sweep-ON

Spectrum emission mask measurement function

The spectrum emission mask measurement function is provided as standard. Pass/Fail measurement based on 3GPP (HSDPA), cdma2000, and other standards can easily be performed with this function.

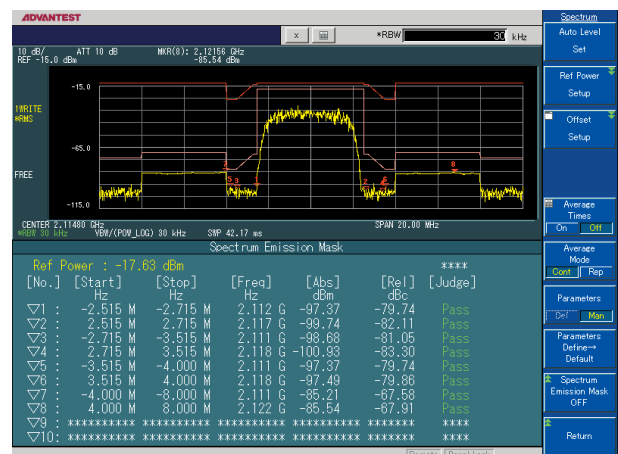
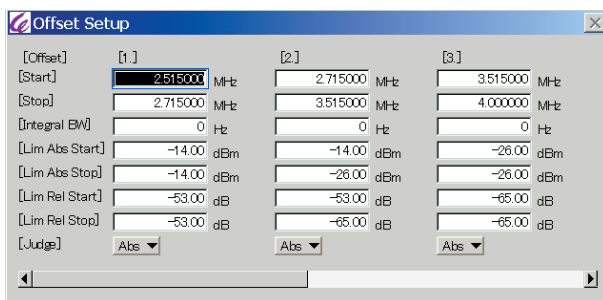

Simple operations for measurements based on digital mobile communication standards

The work of installing a base station of a W-CDMA (HSDPA), cdma2000, or other such system requires various measurement steps. For increased work efficiency, the R3477 is newly equipped with the direct keys (CONFIG key and FUNCTION key) so that even a first-time user can easily perform the intended measurement.

The CONFIG key offers three menu items: Tx Tester, Spectrum Analyzer, and STD Setup. The Tx Tester menu enables selection of any of the measurement items, which are the modulation analysis function, ACP measurement, OBW measurement, and spurious measurement, all of which conform to each of the supported mobile communication standards.

1 First, select a communication standard.

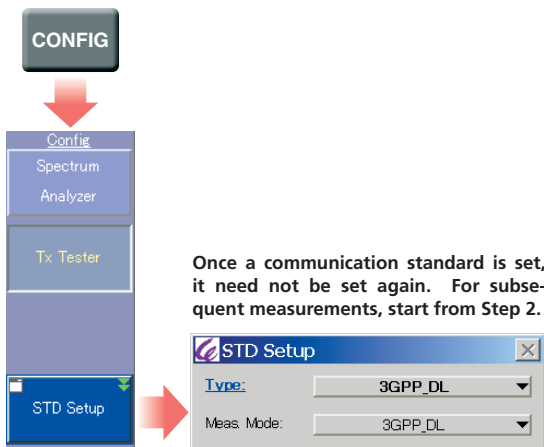

2 Then, all you need to do is start measurement in Tx Tester mode!

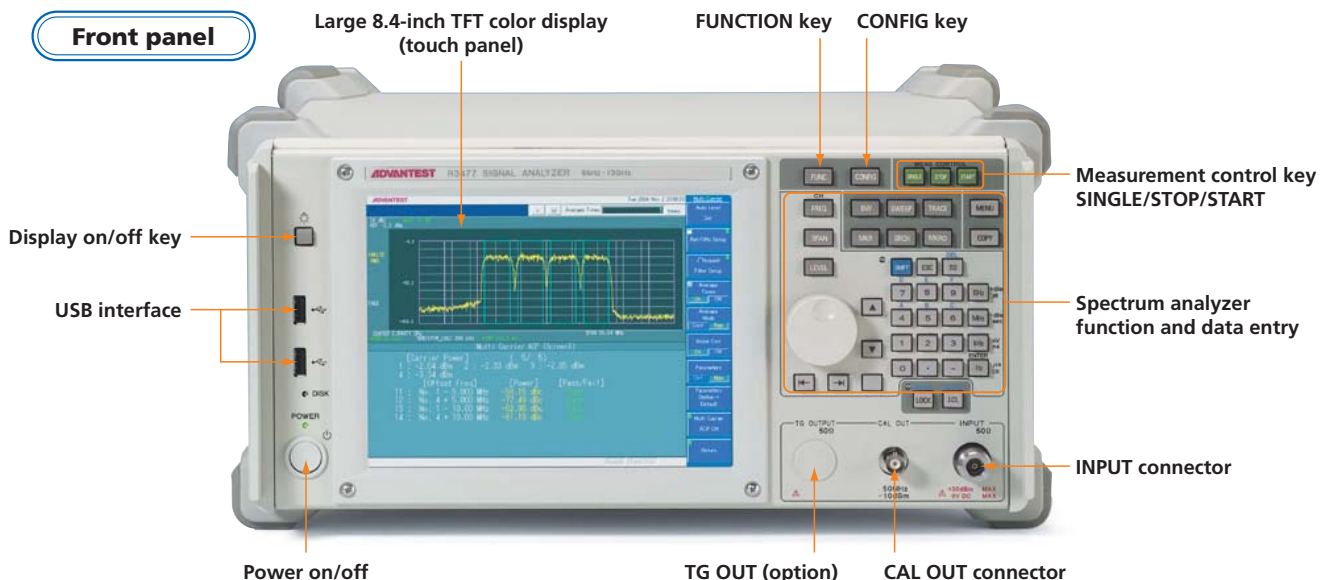
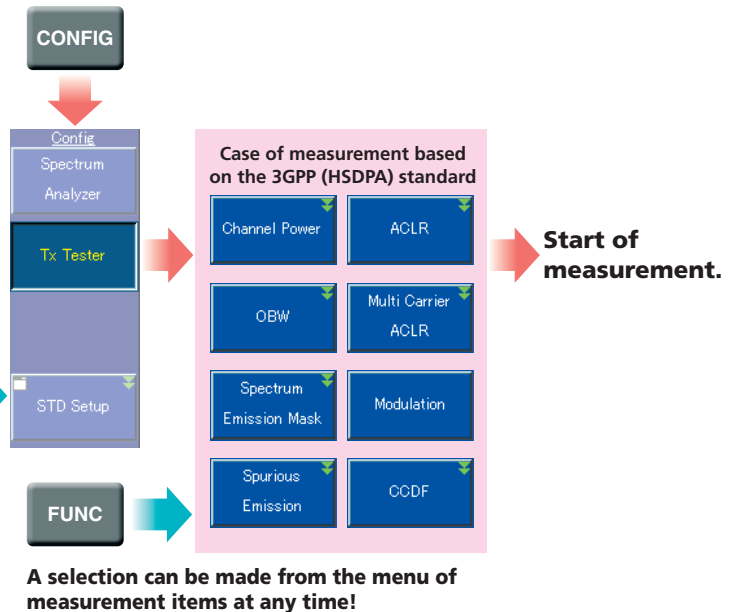

3GPP (HSDPA) modulation analysis software option (OPT. 50)

With the 3GPP (HSDPA) modulation analysis software option (OPT. 50) installed, modulated signal analysis measurement based on the 3GPP standard release 6 can be performed. In addition, ACLR, OBW, spectrum emission mask, spurious, and other such measurements conforming to the standard can easily be performed.

Multicarrier measurement

In multicarrier measurement mode, the modulation accuracy of each of four carriers is measured simultaneously. This simultaneous measurement allows a user to check the interference between these carriers.

Total result (numeric)

- τ (μsec , chip)
- Carrier frequency error (Hz, ppm)
- EVM (%rms)
- Peak CDE (dB)
- Code number of PCDE
- Tx power (dBm)
- P-CPICH (dBm)

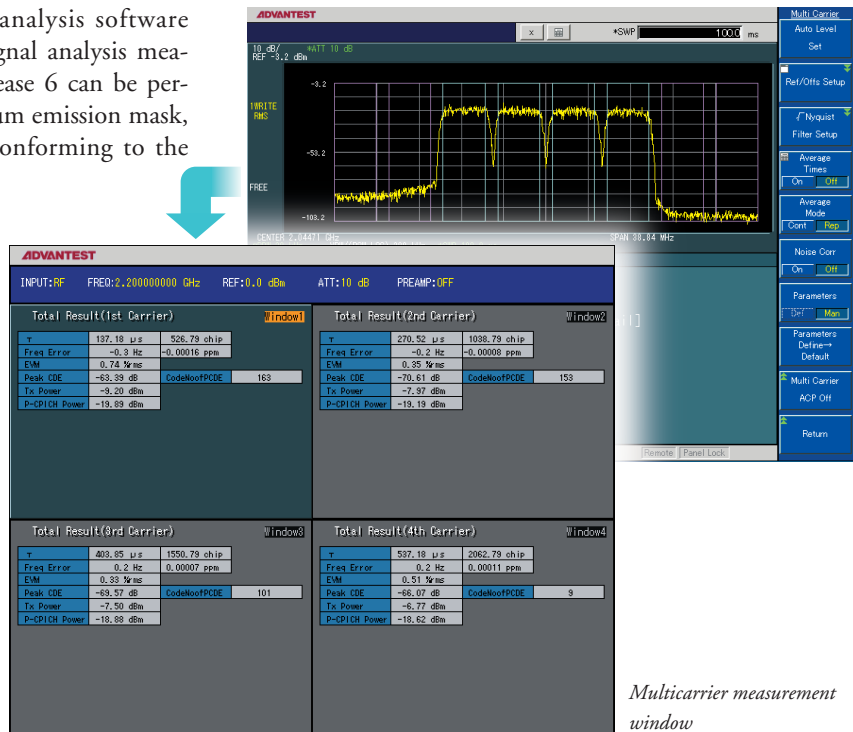

Multicarrier measurement window

cdma2000 (1xEV-DV) modulation analysis software option (OPT. 52)

With the cdma2000 (1xEV-DV) modulation analysis software option (OPT. 52) installed, modulated signal analysis based on the cdma2000 standard release C can be performed. Numerical results that include ρ , EVM, and frequency errors and graphs that include code domain analysis results can be displayed at the same time. In addition, OBW, spectrum emission mask, spurious, and other such measurement conforming to the standard can easily be performed.

Analysis of a channel whose modulation method has changed

The cdma2000 DV channel uses different modulation methods depending on the data rate. When a diffusion code is specified and a power-and-time graph is displayed, changes to power and modulation methods can be measured.

Code power vs. PCG

- PCG
- Mod
- Power (dBm, W)



Specified code measurement window

Maintenance of mobile communication base stations by remote operation

Remote operation of the R3477 can be performed from an external PC on which Windows® XP is installed.*1 Such remote operation is performed via the R3477 LAN interface. The R3477 can be installed at mobile communication base stations without operators, and different settings can be made while measurement results of the sites are being monitored by an administration station. The R3477 is best suited for users who want to comprehend the signal conditions at the sites and to monitor output signals.

*1: In anticipation of possible power failures, consider using an uninterruptible power supply with the R3477.



Large-capacity USB memory

The R3477 is equipped with two USB interface systems (USB 1.1 is used). When a copy device is specified with a soft key, a screenshot can easily be saved as a PNG or bmp file in USB memory. Since the size of such data stored as a PNG file is about 10 KB, more than 5,000 screenshots of data or measurement conditions can be stored in a 64 MB USB memory device. In a PC environment, data can be accumulated, and measured data can easily be edited for reports.

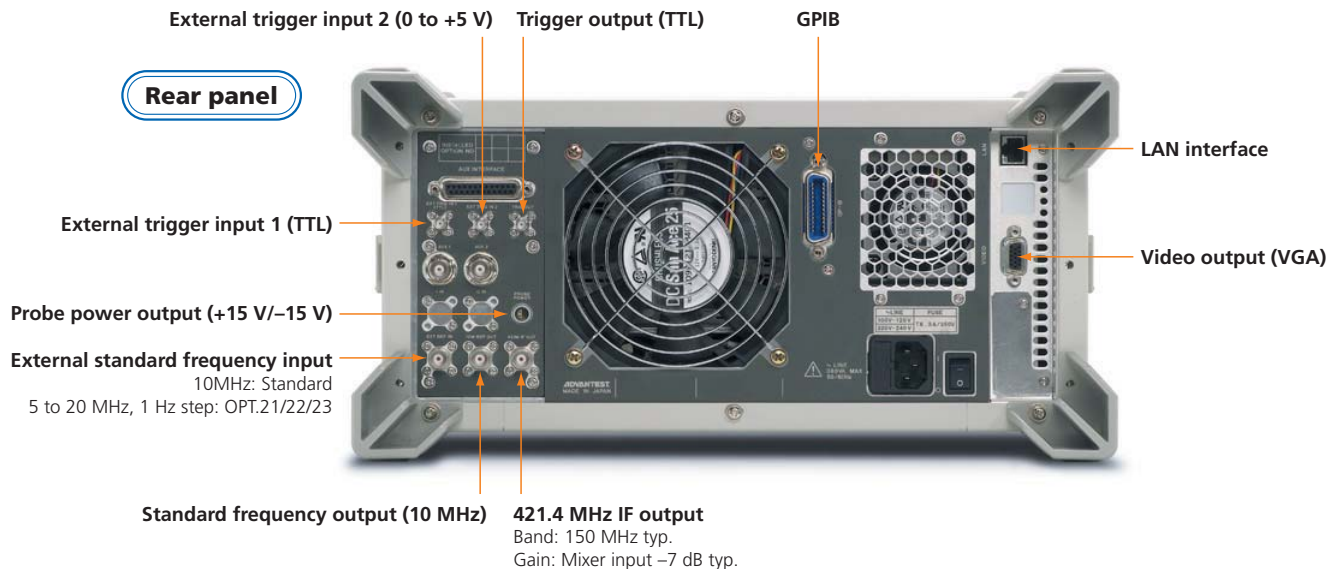
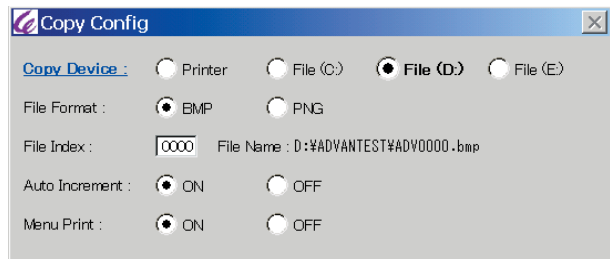

Specifications

Frequency

Frequency Range (spectrum analysis mode)

Preamplifier off:	9 kHz to 13.5 GHz
Preamplifier on:	100 kHz to 3.3 GHz

Resolution bandwidth:	1 Hz to 10 MHz (sequences 1, and 3)
-----------------------	-------------------------------------

Sweep

Sweep time

Zero span:	1 μ s to 6000 s
Span > 0 Hz:	2 ms to 2000 s

Trigger source:	Free-run, Video, IF, Line, Ext 1 (TTL level), and Ext 2 (0 to +5 V)
-----------------	---

Amplitude

Amplitude measurement range

Preamplifier off:	+30 dBm to average display noise level
Preamplifier on:	+30 dBm to average display noise level

Maximum safety input level (input ATT.: ≥ 10 dB)

Average continuous power	
Preamplifier off:	+30 dBm
Preamplifier on:	+13 dBm

Input ATT. range:	0 to 75 dB by 5 dB steps
-------------------	--------------------------

Detector modes:	Normal, positive peak, negative peak, sample, and average (RMS, video, and voltage)
-----------------	---

Amplitude accuracy

Frequency response

(input ATT.: 10 dB, and temperature range: 20 to 30°C)

Preamplifier off	
50 MHz to 2.5 GHz:	± 0.4 dB
9 kHz to 3.3 GHz:	± 1.0 dB
3.3 GHz to 7.5 GHz:	± 1.5 dB
7.5 GHz to 13.5 GHz:	± 2.0 dB

Dynamic range

Average display noise level

(input ATT.: 0 dB, and temperature range: 20 to 30°C)

Preamplifier off	
10 MHz to 1 GHz:	< -156 dBm (typical: -158 dBm)
1 GHz to 2 GHz:	< -154 dBm (typical: -156 dBm)
Preamplifier on	
10 MHz to 1 GHz:	< -162 dBm (typical: -168 dBm)
1 GHz to 2.5 GHz:	< -160 dBm (typical: -166 dBm)

1 dB gain compression (preamplifier off)

200 MHz to 3.3 GHz:	$> +6$ dBm (typical: $+9$ dBm)
---------------------	--------------------------------

2nd order harmonic distortion (preamplifier off)

50 MHz to 1.65 GHz:	< -60 dBc (mixer level: -20 dBm)
720 MHz to 958 MHz:	< -100 dBc (mixer level: -10 dBm, input filter: ON)
> 1.65 GHz:	< -100 dBc (mixer level: -10 dBm)

3rd order intercept point (TOI) (preamplifier off)

1 GHz to 2 GHz:	$> +21$ dBm (typical: $+25$ dBm)
2 GHz to 3.3 GHz:	$> +22$ dBm (typical: $+26$ dBm)

General specifications

Operating environment range:	Ambient temperature: 0 to +50°C Relative humidity: 80% or less (No condensation)
------------------------------	--

Storage environment range:	Ambient temperature: -20 to $+60$ °C Relative humidity: 80% or less (No condensation)
----------------------------	---

AC power input:	100 to 120 VAC, 50 Hz/60 Hz 220 to 240 VAC, 50 Hz/60 Hz (automatic switching between 100 VAC and 220 VAC)
-----------------	---

Power consumption:	360 VA or less Approx. 250 VA (excluding options)
--------------------	--

Dimensions:	Approx. 365 (W) x 177 (H) x 417 (D) mm (excluding protrusions, such as handles and feet)
-------------	---

Mass:	18 kg or less (excluding options)
-------	-----------------------------------

Ordering information

Main unit	
Signal analyzer:	R3477

Accessories	
Power cable:	A01412
Input cable (50 Ω):	A01037-0300
N-BNC adapter:	JUG-201A/U

Option	
High stability frequency standard ($\pm 5 \times 10^{-9}$ /day):	OPT.21
High stability frequency standard ($\pm 3 \times 10^{-10}$ /day, $\pm 2 \times 10^{-8}$ /year):	OPT.22
Rubidium frequency standard ($\pm 1 \times 10^{-10}$ /month):	OPT.23
3GPP modulation analysis software (supporting HSDPA):	OPT.50
cdma2000 modulation analysis software (supporting 1xEV-DV):	OPT.52
6 GHz broadband converter:	OPT.71
Tracking generator:	OPT.79

Microsoft and Windows are registered trademarks of Microsoft Corporation in the United States and other countries.

Please be sure to read the product manual thoroughly before using the products.
Specifications may change without notification.